



## Additive manufacturing of heat exchangers in aerospace applications: a review

Francesco Careri<sup>a,b,c</sup>, Raja H.U. Khan<sup>d</sup>, Catherine Todd<sup>e</sup>, Moataz M. Attallah<sup>c,\*</sup>

<sup>a</sup> National Structural Integrity Research Centre (NSIRC), Cambridge CB21 6AL, UK

<sup>b</sup> EPSRC Centre for Doctoral Training in Topological Design, University of Birmingham, Birmingham B15 2TT, UK

<sup>c</sup> School of Metallurgy and Materials, University of Birmingham, Birmingham B15 2TT, UK

<sup>d</sup> TWI Ltd, Cambridge CB21 6AL, UK

<sup>e</sup> Meggitt Plc, Pilot Way, Ansty Park, Coventry CV7 9JU, UK

### ARTICLE INFO

#### Keywords:

Additive manufacturing (AM)  
Heat exchangers (HXs)  
Aluminium alloys  
Laser-powder bed fusion (L-PBF)  
Heat treatments

### ABSTRACT

The current review is mainly focused on exploring Additive Manufacturing (AM) methods suitable for the fabrication of complex-shaped compact Heat Exchangers (HXs) used in the aerospace industry. The introduction of Additive Manufacturing technologies, thanks to the freedom of design and the ability to produce topologically optimised complex parts, aims at the production of high-efficiency Heat Exchangers. These new Heat Exchangers are characterised by very thin features and a substantial reduction in the weight of the parts compared to the products conventionally manufactured, maintaining a leak-proof structure and excellent mechanical properties. The current L-PBF systems along with software packages are not yet fully ready for the creation of thin leak-proof features needed for highly efficient complex-shaped compact Heat Exchangers and most of the studies in the literature are in the initial development stages. This literature review is covering the current advanced manufacturing technologies which can be employed to manufacture the new generation of compact Heat Exchangers, with particular reference to the Laser-Powder Bed Fusion. The advantages and the current challenges of the Additive Manufacturing processes are described. Furthermore, the state-of-art of topological optimisation and CFD analysis as design tools to support the production of additively manufactured were critically analysed. Finally, new criteria of how to down-select compact Heat Exchanger materials for Additive Manufacturing in the aerospace industrial sector are presented, with particular attention to Aluminium alloys.

## 1. Introduction

Heat exchangers (HXs) are indispensable in several applications. In general, a heat exchanger (HX) is used to transfer heat between fluids, usually in motion, to get rid of the excessive heat generated during a process or operation of a component. In particular, in aerospace applications, HXs are essential to ensure the proper functioning of ultra-high bypass ratio turbofan engines. In particular, air to oil HXs are often used to cool the oil that lubricates the internal rotating components of aero-engines. For this, HX is inserted in the front part of the aero-engine, typically on the fan-case, as expressed in Fig. 1 and must necessarily operate at high temperatures, severe corrosion and wear conditions, mostly for aircraft with longer standstill times in areas with ocean-atmosphere, dynamic vibrations and long periods of operation [1].

Due to the complex heat transfer surfaces within the external case,

aerospace HXs are conventionally produced through a long process, by assembling thin plates by brazing or diffusion bonding. Brazing is a joining process that uses a filler metal with a lower melting point than the base materials being joined. The process creates a strong bonding and increases properties such as corrosion resistance but it is not completely suitable for very large components with several joints and requires high skilled and experienced operators to achieve optimal results. The innovative diffusion bonding, allows a better and easier union between the metallic parts, leading to high-performance compact HXs. In particular, this process consists in applying high temperature and high pressure to bond the plates with no melting or deformation of the shape. However, the process requires specialised equipment and a long process time. Furthermore, the success of the joining relies on surface preparation and close contact between the surface, restricting the range of application for complex geometries. Over the years, the aerospace

\* Corresponding author at: School of Metallurgy and Materials, University of Birmingham, Edgbaston, B15 2TT, UK.

E-mail address: [m.m.attallah@bham.ac.uk](mailto:m.m.attallah@bham.ac.uk) (M.M. Attallah).

<https://doi.org/10.1016/j.applthermaleng.2023.121387>

Received 9 May 2023; Received in revised form 30 July 2023; Accepted 15 August 2023

Available online 19 August 2023

1359-4311/© 2023 The Authors. Published by Elsevier Ltd. This is an open access article under the CC BY license (<http://creativecommons.org/licenses/by/4.0/>).

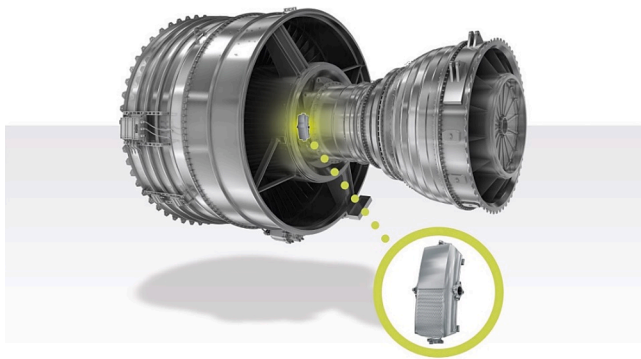

Fig. 1. Conventional HX for an aero-engine (courtesy of Meggitt Plc.) [2].

industry has achieved great technological improvements and nowadays the components of an HX are made more efficiently in order to minimise waste [3]. However, the development of new and more efficient HXs is still ongoing. It is of primary importance to reduce the final weight of the component, by acting on the size/weight, while the performance in terms of thermal efficiency must reach high levels [4]. Consequently, there are several main objectives during the design and manufacture of an HX that result in challenges from an engineering and production cost point of view.

Today's requirements for the correct manufacture and operational life of all components used in the aerospace field, whether civil or military, together with the most stringent rules on environmental impact have forced the industry in the sector to a new vision of HXs, leading to the modelling of complex systems that very often cannot be achieved through conventional manufacturing techniques due to their limited versatility in modelling geometries with complex features. Furthermore, this new regulation has led to the consideration of new types of manufacturing technologies and, therefore, materials with a high density/strength ratio.

This study proposes to fill the gap in a description of the evolution of HXs and manufacturing techniques necessary for the correct production of the new generation of HXs. In particular, a detailed description of AM techniques, with particular attention to Laser-Powder Bed Fusion, and the advantages and limitations of these new manufacturing technologies are provided. In addition, the wide range of materials and post-processing strategies currently used are also explored with particular interest in the advanced Aluminium alloys.

## 2. Heat exchangers (HXs)

Heat Exchangers (HXs) are widely present in all major industrial fields being an essential component of most engineering systems. The design is often a complex balance between maximising the surface area of the part and minimising the pressure drop within the part.

Usually, HXs can be classified in various ways, such as based on transfer mechanism, nature of the process, fluid flow, and compactness. In particular, this review focuses on compact heat exchangers. Compact HXs are characterised by a large amount of heat exchange surface per unit of volume. Maximising heat transfer by minimising the total volume of the component is the basis of the design of a compact HX. These compact HXs have found wide use in the aerospace and aeronautical sectors thanks to the combination of relatively small volumes and consequently low weight and high thermal efficiency [5].

### 2.1. Current status, challenges and the future direction of technology

Compact HXs are mainly used in the aviation and automotive industries. In particular, given the stringent requirements of aeronautical and aerospace applications, the most commonly used HXs are of the finned plate type. The particular design is indeed easily achievable by

brazing the fins and can be easily designed according to the predefined characteristics of the final application. Cross-flow plate HXs have prevailed in the aerospace industry thanks to their compactness, high performance, and ease of system integration [6].

The scientific community is still exploring new design tools and manufacturing methods to address the existing limitations of these HXs and maximise the thermal efficiency coupled with an extreme compactness and low weight of the components. Many details of an HX are ultimately driven not by the performance requirements, but by manufacturing capability. Understanding the influence of variables such as pitch, fin height, and fin thickness is therefore essential to repeatedly produce a lightweight, high-performance HX [7]. In the past, numerous studies on the correlation between fin shape and thermal efficiency [8–12] have led to the design of new HXs. Conventionally, the types of fins used are the result of sheet metal forming or bending processes, and the geometries must allow easy joining on the final component. This reduces the possible combinations of geometries to be used for the generation of new and more functional HXs.

Modern industry has now reached a level of technological advancement that guarantees the overcoming of the limits described above. In particular, the combination of two new technologies, topological optimisation in the design phase and AM in the construction phase, has allowed the expansion of the production space of HXs, increasing the possible categories and, with some limitations, potentially helping to improve the performance for aerospace and other applications.

Topological optimisation is a mathematical technique that uses variable design parameters and constraint conditions for the generation of shapes that guarantee the maximisation or minimisation of one or more objective functions. In particular, to satisfy the constraint condition, the maximum or minimum value of the objective function has been reached by adjusting the value of the project parameter, which is the achievement of optimisation [13]. This useful tool, coupled with advanced computational modelling software and AM technology, can create HX designs with optimised surfaces and low weight, some examples of which are shown in Fig. 2.

The increased need to maximise heat dissipation and performance has introduced new visions of HX design. The use of lattice structures, for example, was proven to be a possible method to enhance the heat transfer and consequently the efficiency of an HX [17]. A lattice structure is a structure composed of solid struts, topologically ordered in a periodic arrangement called a cell that is repeated one or more times [18]. The lattice structures guarantee remarkable mechanical resistance resulting in highly efficient load support systems and also provide interesting possibilities for crossflow heat exchange. The heat coming from the hot fluid is locally dissipated through the reticular structure by conduction and convection thanks to a crossflow of a cold fluid that propagates through the passages of the pores. The combination of high thermal conduction and convection and low flow resistance in empty areas of the lattice structure results in highly efficient heat exchange [19–21]. Traditionally, lattice structures are produced using conventional manufacturing techniques, which have many limits in the number of architectures [17]. The introduction of modern AM techniques, on the other hand, has expanded the possible geometries that can be created [22,23]. Currently, investigations on the use of hollow structures are ongoing. The combination with a lattice structure crystalline structure could significantly increase thermal efficiency. These new hollow walled HXs, manufactured via AM have great potential for industrial development, but the relationships between heat transfer, losses, and type of structure still need to be properly evaluated [24,25]. Nevertheless, some limits of lattice structures and thin features manufacturability through AM remain a challenge that scientific research is still trying to face. The limits in minimum and maximum inclination, thickness, and accuracy do not always guarantee the realisation of the intricate and thin geometry of complex architectures.

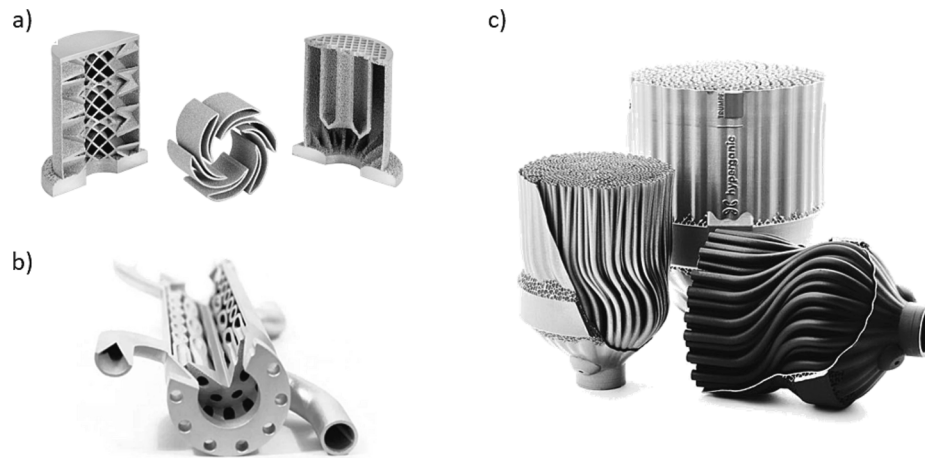

Fig. 2. Novel HXs produced using optimisation models and AM. a) 3D printed HXs (courtesy of Mott Corporation, Farmington, CT, USA) [14], b) monolithic HXs printed (courtesy of Stratasys Ltd.) [15], c) new generation of heat transfer components (courtesy of Hyperganic Group GmbH) [16].

### 3. Additive manufacturing of HXs

AM is a modern manufacturing process that offers great flexibility and opportunities to create new products with complex geometries. AM is starting to have a great impact in recent decades in industrial sectors where products are difficult to make with traditional manufacturing techniques, and where the waste of raw materials is very high. Furthermore, the introduction of AM has made it possible to implement techniques such as topological optimisation, allowing an increase in performance by reducing the weight of the components. Consequently, the use of these processes for manufacturing components in the aerospace sector has increased the opportunities for innovation and provided new ways of manufacturing HXs.

#### 3.1. AM technologies to manufacture HXs

According to the standard ISO/ASTM 52900:2021 [26], there are currently 7 (seven) categories of AM processes, and they are described in Table 1. Most of these technologies are useful tools for creating prototypes, but not all are suitable for metal materials and the production of reliable components to be put in operation. Four of these technologies can produce metal final parts, and there are Direct Energy Deposition (DED), Powder Bed Fusion (PBF), binder jetting (BJT), and sheet lamination (SL). In particular, BJT is a process in which a printhead selectively deposits a liquid binding agent on a thin layer of powder particles (ceramic, metal and composites). Repeated layer by layer, the process can manufacture complex components. The binder is then extracted

Table 1  
Current definition of categories for AM processes [26].

AM Processes Categories		
BJT	Binder Jetting	Process in which a liquid bonding agent is selectively deposited to join powder materials
DED	Directed Energy Deposition	Process in which focused thermal energy is used to fuse materials by melting as they are being deposited
MEX	Material Extrusion	Process in which material is selectively dispensed through a nozzle or orifice
MJT	Material Jetting	Process in which droplets of feedstock material are selectively deposited
PBF	Powder Bed Fusion	Process in which thermal energy selectively fuses regions of a powder bed
SHL	Sheet Lamination	Process in which sheets of material are bonded to form a part
VPP	Vat Photopolymerisation	Process in which liquid photopolymer in a vat is selectively cured by light-activated polymerisation

through a curing and sintering process. Usually, the final density of parts produced by BJT is lower than with PBF technologies with a large amount of porosity due to the binder removal process [27]. It is commonly used for ceramics HXs due to its complex manufacturability.

DED is a process that concentrates a high energy source to melt metals which are supplied in the form of a powder or wire. The focal point of energy, usually a laser, is also where the material is released. As a result, localised melting occurs, followed by rapid solidification. A nozzle moves to create the shape of the single layer, and the part is built layer by layer. The process is characterised by a high deposition volume capacity per unit of time but also presents some problems concerning residual stresses and high surface roughness [28]. Although DED is able to produce large components, the poor final surface and dimensional accuracy of the products make the process unsuitable for the production of HX characterised by thin features. Ultrasonic Additive Manufacturing (UAM), is considered a technology that falls into the SL category. This technology uses ultrasonic friction to join thin metal sheets. Then, the layer is worked through subtractive processes to create the desired geometry. The process is repeated layer by layer until the generation of the final component [29]. Through this technology, it is possible to join dissimilar metals and is therefore advantageous in the aerospace sectors where lightweight and performance in harsh environments due to the high altitude and speed, and weather conditions are essential. Consequently, many ongoing studies on the development of UAM for the manufacturing of HXs are trying to demonstrate the technology's great manufacturing capabilities and investigate its limitations [30].

PBF, is by far, the most widely used AM approach for large-scale production of metal parts. Its popularity is largely due to the inherent simplicity of the process coupled with the wide range of materials available. PBF technologies generally use a laser or an electron beam as a source of thermal energy. Nowadays, both sources are considered valid from an industrial production point of view and the selection of the optimal system is only a function of the technical, economic, and process characteristics of the intended application. Therefore, PBF is the most common HXs manufacturing process [31–34].

Electron Beam Powder Bed Fusion (EB-PBF) is a process that uses an electron beam as a source of thermal energy and base material in the form of a metal powder. A representation, both real and schematic, is described in Fig. 3. This electron beam is directed by a series of magnetic lenses on different points to create several pools of fusion at the same time. The use of magnetic lenses makes the EB-PBF incompatible with ferrous metals due to possible magnetic interference. A drawback of the electron beam energy source is the necessary creation of a vacuum within the system prior to the manufacturing process. Creating the vacuum is relatively time-consuming to respond to processes using a

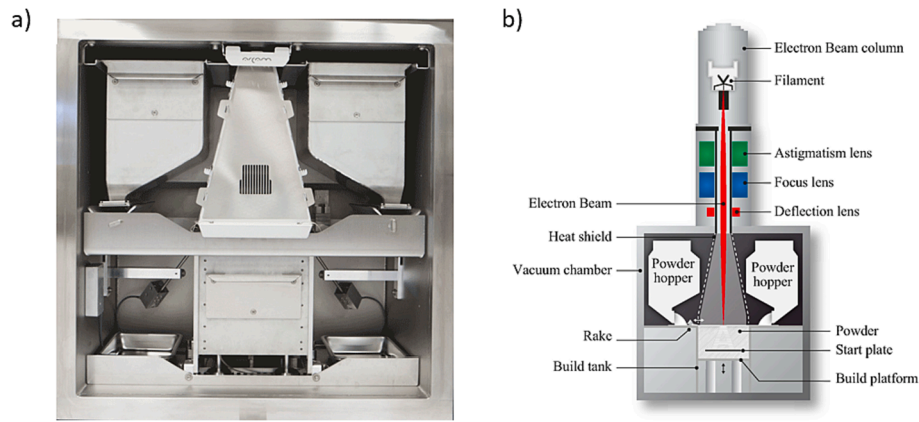

Fig. 3. EB-PBF process. a) View of the process chamber of a commercial GE Additive Arcam EBM (courtesy of GE Additive) [38] and b) schematic representation of the EB-PBF process [39].

protective gas environment but results in several advantages during manufacturing. The vacuum environment guarantees easy control of the temperatures involved in the process which results in a thermally stable operating environment even at high temperatures [35]. The high level of energy used in the process is able to provide high melting capacity and productivity. The materials used in an EB-PBF process are relatively few and, for the most part, refractory and resistant materials, including niobium, molybdenum, tungsten, zirconium, titanium, their alloys and many others [36]. EB-PBF is therefore particularly beneficial to the aeronautical and aerospace industries, creating new opportunities for both prototyping and low-volume manufacturing. Nevertheless, disadvantages such as the complex physics of the process and the not yet understood relationship between process parameters and repeatability of the characteristics of the parts produced, make this process unstable in the industrial field. Several scientific research has been carried out to give a broader overview of the technology, the mechanical and surface properties downstream of the process, and numerical analyses [37].

The machines currently on the market are shown in Table 2. The current market is seeing an increasing number of commercial and non-commercial machines available. In particular, five manufacturers produce twelve different commercial machine models.

Laser Powder Bed fusion (L-PBF) technique, represented in Fig. 4, consists in depositing through a recoater a layer of powder of defined thickness, contained in the powder chamber, in the build chamber. Subsequently, a laser beam is directed to the areas of interest through a lens mechanism and generates a melt pool, while an inert gas (usually Argon) removes the fumes created by the melting of the material and the excess powder. This step is repeated several times, to create, layer-by-layer, the final solid body [41–43].

A broader overview of the physical process and the influence of process parameters is given in Section 3.2.

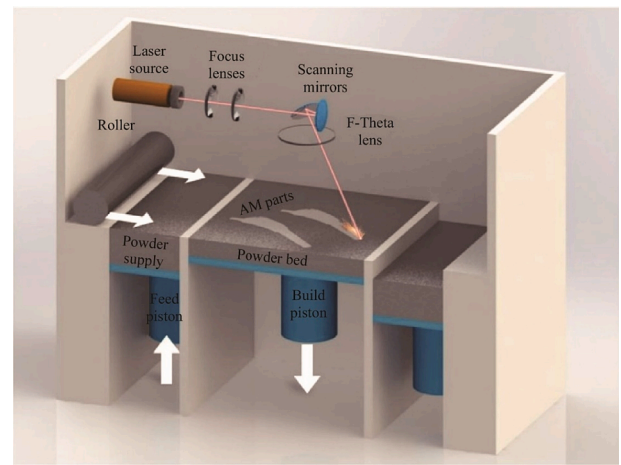

Fig. 4. Schematic representation of a L-PBF process [44].

### 3.2. L-PBF system and process parameters influence

Powder Bed Fusion Laser Beam (PBF-LB), more commonly known as Laser Powder Bed Fusion (L-PBF), also previously called Selective Laser Melting (SLM), is an AM process that uses a laser beam as a heat source to fuse metal powders. The starting point of the process is the creation of a 3D CAD model, subsequently divided numerically into several finished layers, through a software process called slicing. For each sliced layer, a scan pattern is computed, defined as a laser path to trace the component outline and fill sequence. Each layer is then sequentially recreated by fusing sections of the CAD model onto a layer of powder using a laser beam. After creating each layer, the powder is distributed evenly from a

Table 2  
Commercial EB-PBF machines on the market [40].

Company	Country	Systems	Build Volume [mm]	Material	EB Power [kW]
GE Additive Arcam	Sweden	A2X	200 × 200 × 380	Ti, Ni alloy, Ti aluminide	3
		Q10 plus	200 × 200 × 180	Ti, Co-Cr, Cu	3
		Q20 plus	350 Φ × 380	Ti	3
		Spectra L	350 Φ × 430	Ti	4.5
		Spectra H	250 Φ × 430	Ti, Ti aluminide, Ti alloy, SS	6
Freemelt	Sweden	ONE	100 Φ × 100	Non-magnetic	0–6
Tianjin Qingyan Zhishu Technology Co., Ltd (Qbeam)	China	Lab 200	200 × 200 × 240	Ti alloy, superalloy, Cu alloy, refractory	3
		Med 200	200 × 200 × 240	Ti	3
		Aero 350	350 × 350 × 400	Ti alloy, Ni- alloy, Cu alloy, Ti aluminide	3
Xi'an Sailong Metal Materials Co., Ltd	China	S200 Production	200 × 200 × 200	Ti alloy, Ti-Al, SS, refractory	3
		Y150 Biomedical	150 × 150 × 180	Ti alloy, Co-Cr, Ta, Ta ally	3
Tada Electric (Mitsubishi Electric Group)	Japan	EZ300	250 × 250 × 300	n.a.	6



recoated and the process is repeated. Layer by layer, the melted powder particles solidify to form a component [45]. Several features have made of this process the most widely used metal AM technology in the world. The build chamber is filled with inert gas, usually argon, in order to prevent oxidation and ensure good quality of the manufactured components. Consequently, the flow of argon plays an important role in the final mechanical and surface properties of the parts. Using a homogeneous layer thickness helps to control and improve the quality of the built part. The use of a recoater facilitates the control of the deposited layer of powder which is uniformly distributed on the printing platform and therefore allows a controlled feeding of the material. Finally, the laser beam allows the use of different powers ranging from a few Watts to kW and allows the correct choice of parameters for the creation of an efficient melt pool of different materials [46,47]. The high flexibility offered by the L-PBF technology within a wide range of metallic materials allows the manufacturing of components characterised by customised geometries and complex internal features. L-PBF can create complex gradient structures to reduce the necessity to combine several components to manufacture a tailored part. These advantages are behind the strong growth of this technology and have promoted the wide adoption of this process in various industries in recent years [48]. In particular, sectors such as aerospace and automotive look to this technology as the potential development of better and lighter components for use in the operational field. Consequently, the use of the L-PBF process as a means of producing lighter and more efficient HXs is one of the many scientific studies of the past decades. Given the considerable size of a conventional compact HX, it is essential to look for machines that simultaneously have a large printing plate and a large number of lasers that can be used simultaneously. This makes the production process attractive because it guarantees high production volumes in acceptable building times. Furthermore, since HXs have thin section features, it is necessary to consider the minimum thicknesses capable of being manufactured by the machines. The main manufacturers and systems currently on the market are listed below in Table 3.

The main process parameters characteristic of the L-PBF are the laser power, the scanning speed, the spacing of the hatching, the thickness of the layer, and the scan strategy and are represented in Fig. 5. These are used to calculate a fundamental process parameter called Volumetric Energy Density (VED) and are described by Eq. (1) [52].

$$VED = \frac{P}{v \cdot h \cdot \hat{A} \cdot t} \quad (1)$$

where P is the laser power, v is the scan speed, h is the hatch spacing, and t is the layer thickness, respectively. The optimisation of process parameters is necessary to obtain dense materials and minimise defects.

**Table 3**  
Commercial L-PBF systems [48–51].

Company	Country	Systems	Build Volume [mm]	Fibre Laser Power [W]	Minimum Feature Size [µm]
EOS GmbH	Germany	M 300-4	300 × 300 × 400	4 × 400	100
		M 400-4	400 × 400 × 400	4 × 400	
GE Additive Concept Laser	Germany	M Line Factory	500 × 500 × 400	4 × 400	n.a.(laser beam adjustable between100 –500)
		X Line 2000R	800 × 400 × 500	2 × 1000	
SLM Solution Group AG	Germany	SLM® 500	500 × 280 × 365	4 × 400	150
				or	
				4 × 700	
				or	
		SLM® 800	500 × 280 × 850	4 × 400	
				or	
				4 × 700	
3D Systems, Inc.	USA	NXG XII 600	600 × 600 × 600	12 × 1000	
Renishaw plc.	UK	DMP Factory 500 Solution	500 × 500 × 500	3 × 500	300
TRUMPF GmbH + Co. KG	Germany	RenAM 500Q	250 × 250 × 350	4 × 500	n.a.
VELO3D	USA	TruPrint 5000	300 Φ x 400	3 × 500	n.a. (laser beam adjustable between150 –500)
Additive Industries	Netherlands	Sapphire XC	600 Φ x 550	8 × 1000	150
PrimaAdditive	Italy	MetalFABG2	420 × 420 × 400	4 × 500	n.a.
		Print Genius 250	258 × 258 × 350	2 × 500	100

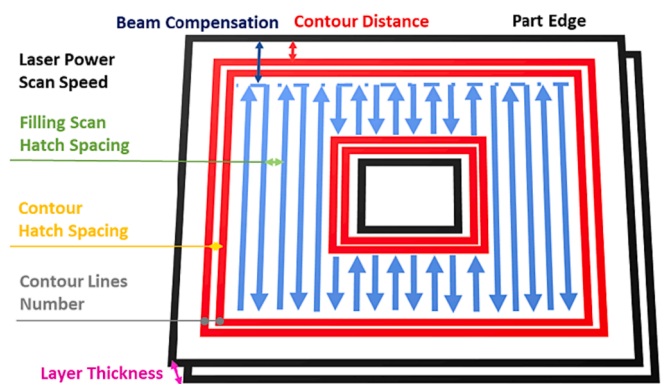

**Fig. 5.** Common process parameters for an L-PBF technology.

Furthermore, the combination of parameters influences the mechanical properties [53], surface roughness [54–56] and process time of the components additively produced through L-PBF.

The effects of process parameters on defects in additive technology have been the subject of study by the scientific community and the relationship can be schematised as in Fig. 6. Porosity is the most common defect encountered during an L-PBF process and can be distinguished in several configurations. Lack of fusion occurs when insufficient energy is applied, leading to incomplete fusion of the metal powder. Incorrect energy can cause balling phenomena, leading to an incomplete and disconnected laser track, and keyhole phenomena. Finally, if the energy sent by the system is too high, it is possible to run into problems of evaporation of alloying elements, the absence of which decreases the mechanical properties of the final component.

Other challenges that characterise L-PBF are the distortions of the components caused by the same residues accumulated during the construction of the parts. The residual stresses are due to the high thermal gradients that occur during the process, caused by the localised heating of the material. This heating causes an initial expansion of the layer followed by a subsequent shrinkage on the parts adjacent to the melt pool formation zone and therefore creates a heat-affected zone. During the construction of the subsequent layers, this phenomenon is repeated, and the component accumulates residual stress which could cause the detachment of the part from the substrate and subsequent distortion. Despite the numerous scientific studies focused on understanding the origin of residual stresses and their eventual control, it is still impossible to obtain a stress-free part and the components must be treated with appropriate thermal stress relaxation treatments before being removed

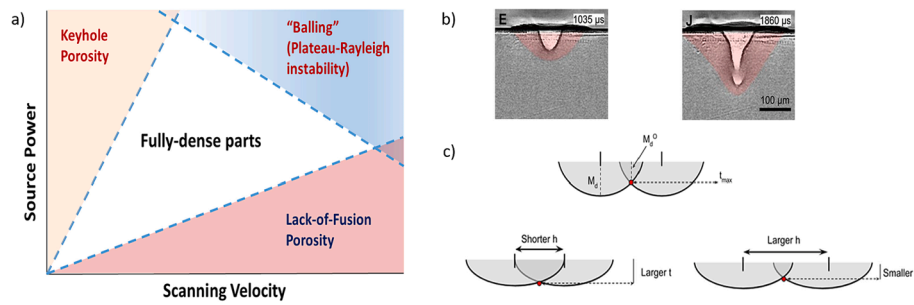

Fig. 6. Influence of process parameters on porosity defect of L-PBF technology. a) Graphic representation of the influence; b) key-hole defect; c) lack of fusion defect [57].

from the substrate [57]. The current solutions to the problems described above are summarised in Table 4.

The microstructures of additively processed materials are generally described by anisotropic mechanical properties due to the dendritic and non-equiaxial microstructure typical of L-PBF. Further problems caused by the incorrect use of optimised process parameters and the formation of dendritic structures are unwanted segregations and precipitations during a process. The presence of segregation zones of alloying elements and the presence of undesired phases can lead to the failure of a component in the operational phase and therefore result in production waste.

#### 4. Modelling and simulation for thermal applications

Various tools have been generated and evolved for the solution of technical and engineering problems. In particular, modelling and simulation are used to develop realistic scenarios and predict the behaviour of a component. The modelling and simulation of heat transfer phenomena is a rapidly growing field. It can be used to improve the operation of existing systems, achieve enhanced results, increase efficiency, and optimise processes. The modelling and simulation of heat transfer is a powerful tool that can be used to improve the design and operation of many engineering systems. In the design of heat exchangers, modelling and simulation can be used to optimise the design for maximum efficiency and minimum weight and volume. This section highlights the state-of-art of heat transfer analysis and optimisation in various HXs applications via a modelling and simulation approach.

##### 4.1. Current status and future direction

The thermal aspects of heat exchangers are complex and challenging to solve. Therefore, many attempts and efforts are needed to realise lightweight, cost-effective HXs capable of exhibiting enhanced efficiencies and environmental performances. These conventional methods

Table 4  
Common solutions to the defects caused by L-PBF process parameters.

Defect	First Approach	Second Approach
Keyhole	Reducing laser power	Increasing scan speed
Lack of fusion	Reduce hatch spacing Reduce layer thickness	Remelting Reduce scan speed Increase laser power Remelting
Evaporation	Reducing laser power Increase scan speed	Increase hatch spacing Increase layer thickness
Residual Stress	Chess (island) scan strategy Use heated substrate	Process in which thermal energy selectively fuses regions of a powder bed

for heat exchanger design and development are time-consuming and expensive. Modelling, and in particular CFD simulation, has emerged as a cost-effective alternative that provides a quick solution in the design phase of HXs. CFD software is versatile and can be used to predict the performance of heat exchangers, identify areas of potential problems, and optimise the design of heat exchangers. Many modelling software is available for thermal analysis and extensive work has been carried out to study and analyse the behaviour of the models for predicting the thermal aspects and optimisation of HXs. One of the most important challenges in CFD simulations of HXs is the accurate prediction of the flow field, typically turbulent and three-dimensional. Another challenge is the accurate prediction of heat transfer rates. The heat transfer rates in an HX are affected by a number of factors, including the flow conditions, the geometry, and the properties of the fluids. The commercially available software uses different methods to solve the equations governing these properties but predicting all the factors is not always achievable and it can lead to errors in the predictions of HX properties [58–60].

The use of artificial intelligence (AI) in control systems has become increasingly important in the past two decades. AI-based techniques can be used to improve the performance of control systems, making them more efficient and reliable. They can also be used to develop new types of control systems that are not possible with traditional methods. AI and computer science models, such as machine learning, can be used to investigate the performance of heat exchangers avoiding experimental and time-consuming computational approaches [61,62]. These methods are able to make accurate predictions and are relatively fast, making them valuable tools for engineers. A significant amount of research is being conducted on using artificial intelligence (AI) techniques, to predict and control the performance of HXs [63–65]. AI techniques can be used to develop models that can predict the performance of HXs under different operating conditions. This information can then be used to optimise the design of heat exchangers and to improve their efficiency. They can also be used to develop control systems that can automatically adjust the operating conditions of HXs to ensure that they are operating at their optimum performance.

The state of the art of modelling and simulations of HXs is constantly evolving. New models and algorithms are constantly being developed and updated in order to achieve more accurate and detailed predictions of the performance of thermal devices and simplify the simulation tools for the flow of fluids and heat transfer in HXs. Furthermore, the use of AI techniques and machine learning to predict and control the performance of heat exchangers is a promising area of research with the potential to improve the design, operation, and efficiency of heat exchangers.

##### 4.2. Tools for AM HXs thermal aspects optimisation

The introduction of AM techniques has increased the use of tools such as topological optimisation and simulation software to enhance the thermal aspects of the HXs. The result is a structure designed to withstand the loads applied in the operational phase, minimising the constituent material. Topological optimisation design and CFD software

were introduced in the structural design phase of high-performance, light and multifunctional structures and are nowadays widely used in sectors such as aerospace, automotive, etc. [66].

Topologically optimised structures are generally characterised by complex geometric configurations. Therefore, conventional processes (e.g. machining, casting) are not suitable for their manufacture. AM enables the freedom of design for lightweight structures and the manufacturing of high complex internal geometries in a single step, difficult or impossible to achieve with traditional manufacturing methods [67,68]. The work of Saltzman et al. [3] illustrates the potential of AM as a single-step manufacturing process for HXs. The authors successfully replicated a conventional aircraft oil cooler HX design using AM techniques. The findings of this study revealed a high surface roughness in the additively manufactured component but demonstrated excellent accuracy in replicating the complex features of the original design. Through comprehensive experimental analysis, the authors evaluated the impact of the significant surface roughness on the pressure drop and heat transfer performance of the additively manufactured HXs compared to their traditionally manufactured counterparts. Despite the presence of typical additive manufacturing defects such as pores and lack of fusion, the produced HXs completed the experimental tests and exhibited superior performance compared to the conventionally manufactured HXs currently in production. However, using CT analysis, several nucleation of cracks was found that could cause component failure. In subsequent work [3], the same author highlighted how some channels for the transport of the hot fluid (oil) were compromised and/or blocked. Furthermore, the results of the experimental test indicated that the significant surface roughness of AM HXs led to a higher pressure drop when compared to conventionally manufactured HXs. However, it was observed that the heat transfer performance of the additively manufactured HXs improved significantly. Significant limitations still need to be overcome in order to make of AM a reliable manufacturing method for industrial HXs. However, the study by Saltzman et al. exemplifies the feasibility of using AM as a single-step manufacturing process for HXs.

The use of topological optimisation has the potential to significantly impact the design of heat exchangers (HXs), offering opportunities to enhance efficiency and performance in HX applications beyond what is achievable with traditional manufacturing methods. The main objectives in the optimisation of an HX are the maximisation of the thermal efficiency, and the minimum pressure drops while maintaining compact dimensions and lightness. Furthermore, the attention on the part of the scientific community [28,58,60,69,70] has increased in recent decades and the development of more powerful finite element and computational fluid dynamics (CFD) software has allowed the introduction of methodologies that, together with topological optimisation, guarantee an overall in the entire decision-making phase of new optimised HXs. The fundamental role of CFD analysis is underscored in the study conducted by Da Silva et al. [71]. The authors employed L-PBF to manufacture a compact HX and subsequently validated the CFD numerical results through an experimental campaign focused on pressure drops and heat transfer. The findings revealed a strong correlation between the numerical and experimental outcomes, emphasising the significance of numerical analysis during the design phase of HXs.

The application of algorithms for the optimisation of the shape and features makes the design process intuitive and helps in the research of optimal solutions [72]. In the study conducted by Moon et al. [73], a shape optimisation genetic algorithm was employed to design a novel HX that could be produced using AM techniques. The genetic algorithm aimed to enhance thermal efficiency by maximising the total surface area while adhering to design constraints. The geometry of the newly developed HX surpassed the limitations of conventional manufacturing methods and was successfully manufactured using L-PBF with an Al alloy. By comparing the additively manufactured HX with a commercial tube-in-tube device as a baseline, the experimental analysis demonstrated a significant improvement in the overall performance of the

newly optimised HX. Moreover, when compared to traditional heat exchangers such as shell-and-tube and brazed plate configurations designed for considerably higher heat transfer, the optimised HX exhibited comparable performance. This notable performance enhancement of the genetically optimised HX can be attributed to its internal architecture, which cannot be achieved using conventional design and manufacturing approaches.

The project developed by three different consortiums, Temisth [74], AddUp [75], and Sogclair [76], depicted in Fig. 7, represents another example. The project [77] aimed to study the topological optimisation of a compact air to oil HX using CFD models and the thermal efficiency of the component. The material selected was Inconel 718, heavier and less conductive material than other alloys such as Al alloys. The authors justified the choice by highlighting how the use of this material through AM allows the creation of thin features excluding leaking defects. However, no experimental test was yet performed to assess the real performance of the component during the operation.

Feppon et al. [78] and Dixit et al. [79], in their works, depicted in Fig. 8, studied the thermal aspects of the generation of HXs using different approaches.

The work of Feppon et al. [78] proposed the constitution of a 2D and 3D optimisation model to modify the HX shape incrementing the thermal properties. Based on the correlation between the velocity and pressure of the fluid, together with a convection–diffusion equation for the temperature fields, the new optimisation tool guarantees the optimisation of the geometrical design taking into account constraints such as input and output, thickness and non-penetration of the components. Although the mathematical method used was purely constructed to optimise the shape through the optimisation of only heat transfer, not considering the influence of constraints such as pressure drop, it was successfully applied to different types of HXs. The newly generated designs, represented in Fig. 8 on the left, are not achievable through conventional manufacturing processes but the AM is able to produce the innovative designs generated by the algorithm. However, also in this case, the authors didn't perform any validation of the model experimentally, leading to gaps in the real validation of both AM manufacturing reliability and operational performance of the new design.

In the work of Dixit et al. [79], depicted in Fig. 8 on the right, a new-generation liquid-to-liquid HX using a gyroids lattice structure was manufactured and tested to prove the ability of AM to create complex geometries characterised by thin features. Both experimental and numerical methods were used to analyse and assess the thermal aspects of the HX. The AMed HX was proved to be leak-proof highlighting the feasibility of the AM process to generate thin walls characterised by 300  $\mu\text{m}$  in thickness. Furthermore, the new design showed a high increment in thermal efficiency compared with a conventional HX. The authors emphasised how the increase in thermal properties of the new generation of HXs produced by AM is to be attributed to the large contact surface density characteristic of the new topological geometries used by modern numerical models.

The available studies and the lack of experimental analysis of the performance of additively manufactured HXs and the comparison with the traditionally manufactured counterpart indicates a non-maturity of the AM method as mass production of HXs. However, ongoing investigations in the fabrication of complex internal features, coupled with the advancements in AM technologies have the potential for achieving a high level of reliability. Specifically, L-PBF, considered the most prominent AM technique, is expected to reach levels of advancements to be embraced in the production of HXs, leading to extensive adoption and standardisation of the technology.

## 5. Technological challenges for AM of HXs

L-PBF is a complex process and requires studies to address the limitations in the fabrication of thin elements. In particular, it is very



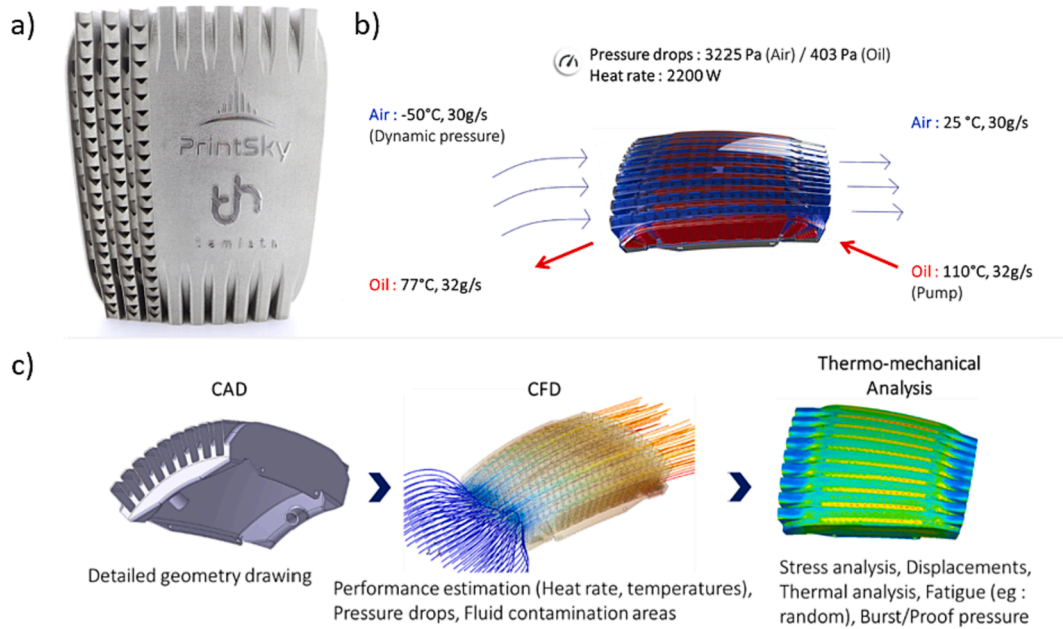

Fig. 7. Topological optimisation and CFD analysis of novel HXs (courtesy of TEMISTh) [77]. a) Additively produced component; b) boundary condition for the CFD analysis; c) phases of CFD numerical approach.

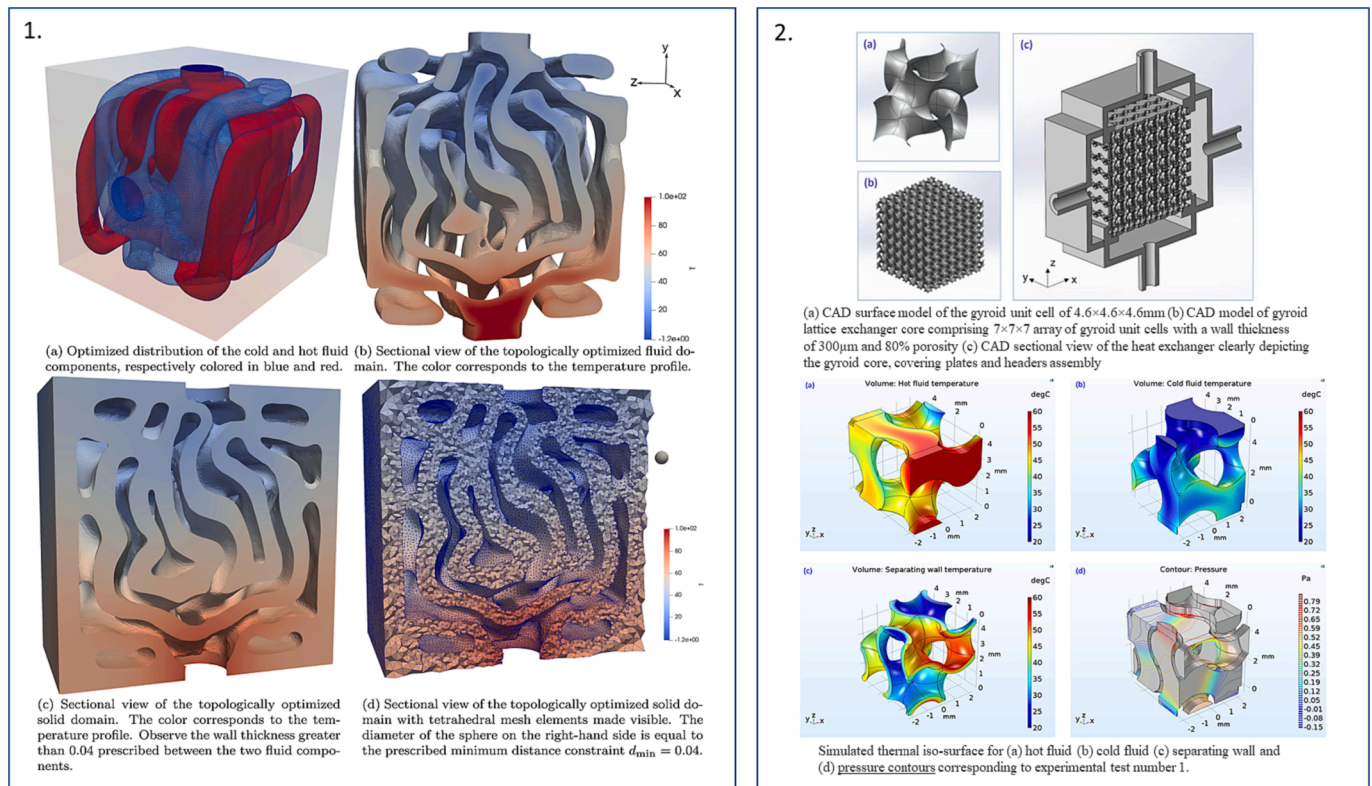

Fig. 8. Representation of optimisation analysis of thermal aspects for the new generation of optimised HXs. Work of Feppon et al. [78] on the left; Dixit et al. [79] on the right.

difficult to create a high-quality, defect-free thin wall or generally a thin feature with a thickness of less than 200–300  $\mu\text{m}$ . In addition, conventional manufacturing methods such as stamping have demonstrated the capability to fabricate plate fins with typical thicknesses ranging from 46 to 200  $\mu\text{m}$  [1]. However, AM has not yet achieved the technical maturity and production quality required for the mass production of these critical attributes necessary for the development of high-

performance heat exchangers [80]. Different types of sources are the cause of the problems. Shrinkage can cause cracks and total breakage of a thin part. Furthermore, in the case of thin-section pipes characterised by complex geometry, the viability of the duct could be compromised by the entrapment of powder and/or inclusions of unfused powder attached to the internal walls. This translates into an increase in internal surface roughness and a decrease in the properties of heat exchange. In addition,



the limitations in the additive process must be considered when designing a component to be made via an additive process and summarised by Mani et al. [81]. Consequently, preliminary studies for the optimisation of process parameters for the production of thin features to be used in HXs are generally carried out.

### 5.1. Manufacturing of thin features for HXs

The L-PBF process does not seem yet suitable for guaranteeing repeatability in the production of thin sections. In particular, the accuracy error increases with the reduction of the thickness dimension of the manufactured component. Significant dimensional variations have been identified between sections in both the horizontal and vertical planes. Furthermore, it has been observed that the distortion of the walls decreases as the thickness of the printed object increases. The work of Wu et al. [82] aimed to generate design guidelines for optimising thin section walls taking into account all possible combinations of L-PBF process parameters. A schematic representation of the work performed by the authors is described in Fig. 9.

Based on the selected parameters, it was observed that a notable lack of fusion occurred primarily when employing a single laser scan approach. The resulting wall thickness of approximately 100 μm was consistent across all three materials investigated in this study, namely Ti6Al4V, Inconel 718, and AlSi10Mg. Furthermore, a maximum inclination angle of 60° was successfully produced for the AlSi10Mg and Ti6Al4V, while only an angle of 45° was able to achieve for the Inconel 718. Two scan strategies, raster and single laser track can be used to produce thin sections, and the correlation between each scan strategy and thermal and shrinkage issues, inclination angle and wall dimension controlling factors was assessed. Porosity was analysed using CT scan technology and a process map for the fabrication of the thin walls correlated to laser power and scan speed was developed. Finally, the surface quality was analysed, discovering a direct relation between inclination angle and material.

Tan et al. [83] and Hassanin et al. [84] analysed the influence of Contour Distance (CD) and Beam Compensation (BC) on the geometrical accuracy of thin designs such as lattice structure and micro-channels

respectively. In both studies, the authors highlighted the challenges in finding the optimal process parameters to improve simultaneously the dimensional accuracy and general quality of the features. Consequently, the construction of thin features through L-PBF and AM processes, in general, is particularly difficult and still a challenge for the scientific community.

### 5.2. Powder removal

Another important challenge for the manufacturing of additively manufactured HXs is the cleaning of complex internal channels. The powder entrapped or sintered in the channels needs to be removed before further post-processing operations and the completion of the manufacturing process. Most of the channels of optimised HXs and/or hollow lattice HXs have no opening or outlet, and therefore powder removal becomes a challenge. There are not many studies in the literature addressing this important issue. Two possible methods underlie the few studies focusing on the problem, design redesign, and the use of equipment and methods after AM of the component.

An example of the first approach is the work of Gutmann et al. [85] in which a reactor for continuous difluoromethylation for the nuclear field has been redesigned to favour the elimination of residual powder due to the AM process. The work is summarised in Fig. 10a. The component was made of SS316L stainless steel via L-PBF and the geometry included a series of holes in the connection points of the channels to facilitate the powder removal at the end of the process. After cleaning the reactor using the ultrasonic technique, the holes were closed by laser beam welding. Analyses performed on the reactor have confirmed the success of this manufacturing strategy.

Hunter et al. [86] proposed in their work a method to detect and remove the powder entrapped in complex features fabricated via L-PBF. In particular, X-ray computed tomography (XCT) and weighing were used to inspect and assess quantitatively the successful ratio of their powder removal methods. A traditional method of ultrasonic polishing with ultrasonic bathing was compared with a new and innovative technique of vacuum boiling. The results of the work of Hunter et al. are represented in Fig. 10b. In particular, the vacuum boiling strategy

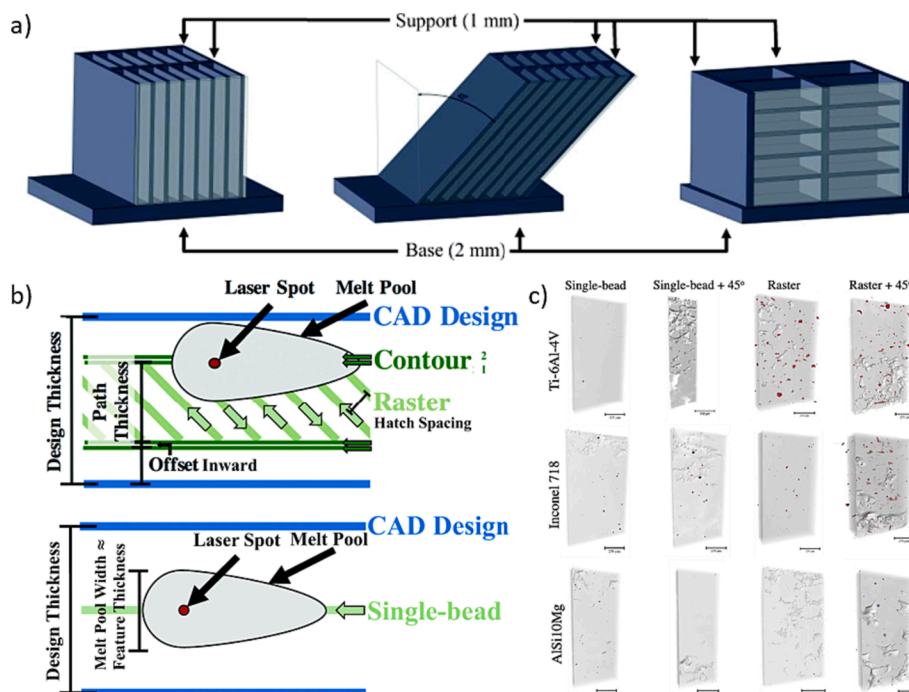

Fig. 9. Influence of L-PBF process parameters on the generation of thin walls [82]; a) schematic representation of the geometries studied in the work; b) schematic representation of different scan strategies for the AM process; c) porosity calculated through μSCT of different materials for the additively produced thin walls.

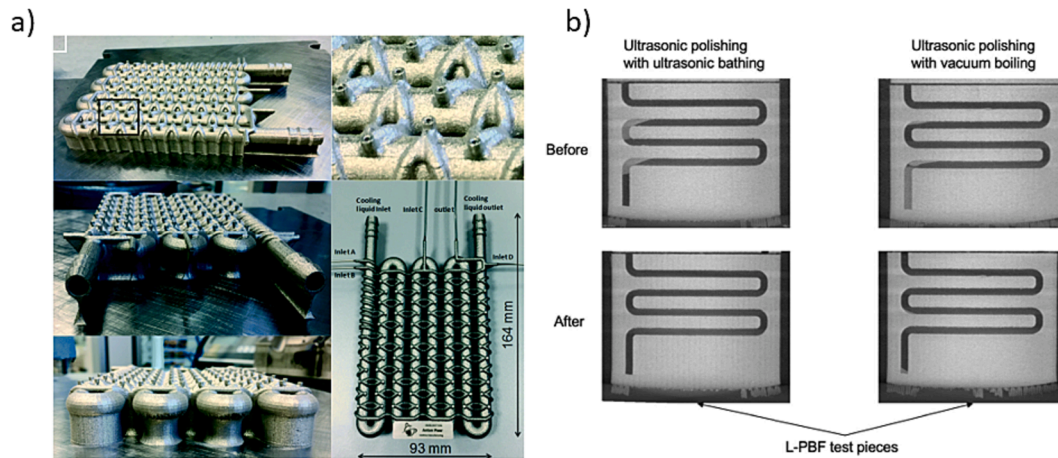

Fig. 10. Powder removal approach. a) First approach: redesign of a component [85]; b) second approach: using a post-processing strategy [86].

involved a depressurised container with the component submerged in water. After the air is evacuated from the container, a heat source brought the water to boiling point causing the formation of water bubbles. The water bubbles help the removal of the powder, and the technique was demonstrated to completely freeing the ducts. This method is easy to implement but cannot be used for metallic materials, especially in powder form, which reacts easily in contact with water or air, such as Al and its alloys. Al reacts with water to produce hydrogen gas due to its highly negative redox potential. Scientific studies have found that the result of this reaction can be a significant accumulation of gaseous hydrogen, even for small concentrations of material. Considering the large, exposed surface of a metal powder particle, the reaction in aqueous environments could lead to the formation of high levels of hydrogen with the achievement of high pressures. This can pose the risk of fire or explosion in wet powder removal systems [87,88]. Therefore, industrial-grade equipment was developed for the purpose to remove the powder from parts fabricated via AM. These specialised de-powdering stations, exemplified in Fig. 11 and detailed in Table 5, consist typically of a wide range of components designed to facilitate the removal of residual powder from the build plate.

Typically operating within a controlled environment that employs inert gas, these stations incorporate filters, sieving components, and various other features to ensure the integrity and quality of the extracted powder.

### 5.3. Fundamental properties of AM HXs

When it comes to HXs, different properties need to be analysed to evaluate the performance of an HX during the operational phases. In particular, for HXs produced through AM, scientific attention is focused

Table 5

Main features and characteristics of two de-powdering systems [91].

Feature	Solukon SFM-AT800/-S	Inert PowderShield
Table size	800 × 400 mm	Φ 533 mm
Max weight	300 kg	50 kg
Vibration	Yes	Yes
Programmable vibration	Yes	No
Access for loading build plates	Yes	No
Inert gas	Yes – optional	Yes – included
Motorised axes of movement	2 axes	None
Maximum rotation/tilt of axes	360°	45°
Robot loading	Yes	No

on surface roughness, microchannels and thin walls, surface geometry, laminar and/or turbulent behaviour, corrosion and finally thermal efficiency. HXs, such as those used in an aircraft engine, operate at temperatures around 200 °C and are not subjected to very high loads. Consequently, they do not require high mechanical properties but surface and geometric properties suitable for heat dissipation. With the technological advancement of AM processes, great improvements can be achieved in the quality of surface quality and realisation of small thicknesses with precision, but scientific research is still far from total mastery of these characteristics [33,34].

#### 5.3.1. Leak-free integrity

Leak-free features are essential for increasing the heat exchange between the two fluids at different temperatures in compact high-performance HXs [32]. AM reduces the risk of leaks as it eliminates the manufacturing step of assembling various thin-section components. However, it also has the disadvantage of possible losses caused by the

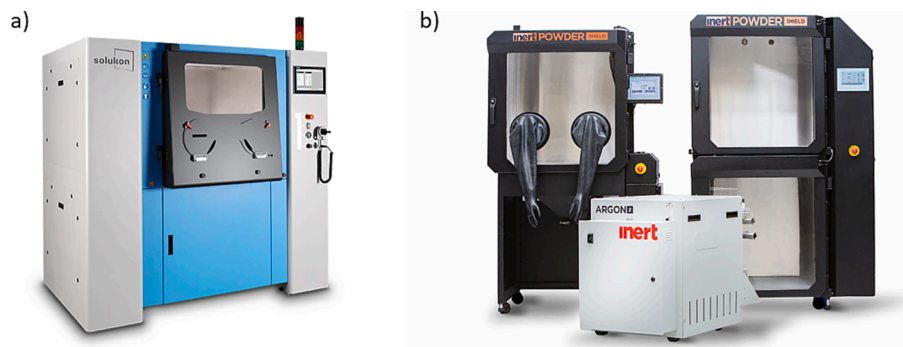

Fig. 11. Two commercial de-powdering systems for AM. a) Solukon SFM-AT800/-S (courtesy of Solukon Maschinenbau GmbH) [89] and b) Inert Technology PowderShield (courtesy of Inert Technology) [90].

formation of defects such as porosity and inadequate union of the layers. Defects such as pores and voids could be weak structural points where the fluid can escape from the duct, mixing with the second liquid. In particular, considering the manufacturing of thin features, a small defect can damage the entire component. Despite the increased interest from the aeronautics and aerospace sectors in new compact HXs characterised by thin features, the study of the leaking problem has not yet attracted the attention of the scientific community. Few studies including that of Sabau et al. [92] performed leaking tests to ensure the success of the additive process, but no author has yet started the research on the correlation between the leaking, its known causes and targeted optimisation to solve this critical issue.

New systems have recently been developed which aim to eliminate internal pores within a printed material through a sequential process, the so-called vacuum impregnation systems. Initially, the component is immersed in a resin bath, while placed inside an autoclave. Subsequently, a vacuum is created to evacuate the air from the component, thereby facilitating the ingress of resin into the voids. Once the impregnation process is completed, the component is withdrawn from the bath, and surplus resin is extracted to ensure optimal impregnation levels. [93].

### 5.3.2. Surface roughness

Surface Roughness is considered the most important characteristic in different types of HX configurations produced by metal AM. The roughness plays a double role as it influences both the actual dimensions of the produced feature (pipe, wall) and the behaviour of the fluid. Usually, a high roughness is synonymous with a significant deviation of the fabricated dimensions from the intended design, especially as the dimensions approach the fabrication limits of the AM machine [33,94]. Many studies [95–98] also demonstrated that high internal roughness of channels increases pressure drops and turbulent behaviour, compared to the traditionally manufactured fins and channels. On the other hand, the performance in terms of heat transfer between traditionally and additively manufactured are in most cases comparable. In their work, Geete and Pathak [99] numerically analysed the effect of the internal roughness of pipes made of different materials on the performance of HXs. In particular, three different surface roughness values were considered and through CFD simulations with predefined boundary conditions, the rate of heat transfer was calculated as output. The authors have shown that a low roughness improves the properties of thermal exchange and they have also settled the influence of the different materials, steel, Cu and Al. According to the study, both surface and material influence heat transfer and pressure drop. In particular, for steel pipe, the authors analysed a linear relation between surface roughness and properties, while, Aluminium and Copper show similar non-linear trends. The results highlighted copper pipes with smooth internal surfaces as the best conditions to enable high thermal performances. Consequently, the objective of many recent research studies [55,100–104] was the optimisation of the parameters of the AM technologies for the tailoring of the surface roughness downstream of the additive process. In particular, Poncelet et al. [102] analysed the influence of L-PBF process parameters on the vertical roughness and hardness of AlSi10Mg thin walls. The authors used a Design of Experiments (DoE) to test different values of the main process parameters, laser power and scan speed during the construction of thin walls characterised by a thickness of 600  $\mu\text{m}$  and ultra-thin walls produced by two single laser tracks. In particular, regarding the ultra-thin walls manufactured using parallel tracks, the offset or distance between melt pools has been identified as a crucial factor in reducing roughness. Larger offsets between melt pools consistently prove advantageous in minimising roughness levels. This can be attributed to the wetting phenomenon that occurs between a melt pool and the adjacent solidified melt pool, resulting in a slight liquid overflow. Everything was compared taking into consideration the final hardness of the as-built steps to understand the relationship between roughness optimisation and mechanical properties of the components.

The results showed that the ideal process values for a low roughness were those close to the formation of the keyhole phenomenon. Consequently, the mechanical properties evaluated in terms of hardness are lower than the average values of an as-built AlSi10Mg. For thin walls, the scanning strategy also plays a crucial role and using a scan contour before a bulk contour seems to give better quality to the surfaces. Finally, the authors believe that further studies must be carried out to determine if the lower levels of hardness and therefore mechanical properties affect the reliability of thin and ultra-thin walls.

### 5.3.3. Fatigue performance

The fatigue performance of additively manufactured materials has been the subject of extensive research and investigation [105,106]. Several factors such as microstructure, residual stresses, and surface roughness influence the fatigue life of any material. In particular, research has focused on specific metals and alloys commonly used in AM, such as titanium alloys, stainless steels, Aluminium alloys, and nickel-based superalloys. These studies [107–109] have examined the influence of AM process parameters, microstructure, defects, and post-processing treatments on the fatigue performance of these materials. However, the fatigue behaviour of heat exchangers, composed of several complex and thin features, is influenced by other several factors. The combination of cyclic loads at high temperatures and elevated working pressure may give rise to structural concerns. In recent times, the assessment of fatigue in heat exchangers has predominantly relied on numerical simulations. Limited attention has been given to experimental investigations of fatigue in plate and shell heat exchangers, with Martins et al. [110] being one of the few researchers to undertake such studies.

A substantial number of studies have been conducted on the low-cycle performance of thin walls manufactured through AM processes. These studies [111,112] have identified several influential factors affecting the fatigue behaviour of these features. The initial microstructure, often exhibiting anisotropic characteristics, as well as metallurgical defects like porosity and lack of fusion, play a significant role in fatigue performance. Moreover, AM processes tend to result in higher surface roughness compared to conventional manufacturing methods. Extensive research has demonstrated the detrimental impact of elevated surface roughness on the fatigue properties of additively manufactured thin features. However, these limitations can be mitigated through various post-processing treatments, including Hot Isostatic Pressing (HIP), machining, and heat treatments [113]. Nevertheless, a comprehensive understanding of the influence of AM process parameters, microstructure, defects, and post-processing treatments remains incomplete. Ongoing research efforts are focused on further characterising and enhancing the fatigue resistance and reliability of metal AM thin features.

### 5.3.4. Corrosion resistance

Corrosion is a major problem affecting HXs. Corrosion can be caused by several factors including environmental conduction, the fluids used, and wear and erosion. Corrosion failure is quite common during the operational life of an HX, and maintenance and repair costs can be quite long and expensive, especially when it comes to air to oil compact HXs used in the aerospace field [114]. These components in particular are subject to severe environmental conditions, especially in the presence of sea and ocean routes where the strong concentration of salt mist can accelerate the degradation rate of metals. Consequently, the study of the phenomenon of corrosion, and the search for methods, traditional and innovative, for the protection of exposed surfaces, is ongoing. In particular, the effects of post thermal treatment, surface finishing and coating treatments on the corrosion behaviour of additively manufactured materials are nowadays widely assessed [115,116].

### 5.3.5. Post thermal treatments

Due to the intrinsic phenomena during an additive process of L-PBF, the components produced require post thermal treatments to improve



the properties of the material. Generally, the microstructure and mechanical properties of the as-fabricated materials (prior heat treatments) produced through AM are inferior to the counterpart made through traditional manufacturing techniques of casting or forging. The particular thermal cycle of AM processes is characterised by the sudden heating caused by the laser, followed by a rapid cooling and a second melting which simultaneously involves the next layer with a remelting of the underlying and previously solidified layers. These thermal cycles are repeated during the formation of every single layer of an L-PBF process and cause large thermal gradients that form residual stresses on the component. If the stress levels reached are high, a distortion of the geometry of the piece can occur which can lead to damage and malfunction of the product [117,118].

Several approaches have been evaluated to solve this problem. In particular, the use of post thermal treatments for the relaxation of residual stresses remains the most adopted solution in the scientific and industrial fields. Studies [119,120] have indeed shown that post-AM thermal treatment would drastically reduce the dislocation density, which therefore translates into a significant reduction in residual stress.

Post thermal treatments for L-PBF parts are also widely used to increase other material properties, such as mechanical properties and resistance to corrosion and wear [121,122]. The use of post thermal treatments on materials additively manufactured gives properties comparable to or even superior to those of conventional materials. Homogenisation and solution treatments make the microstructure homogeneous and allow the elongated dendritic grains typical of the additive process to be transformed into equiaxed grains. They also allow the diffusion of segregated alloying elements. While through the ageing treatments, the formation of precipitates takes place, which helps to increase the mechanical properties of the material [123–125]. Furthermore, oxidation phenomena occur during thermal treatments which form a protective oxide layer on a wide range of materials. This helps to increase the performance in terms of corrosion and wear resistance [124–126].

## 6. Materials selection for AM HXs

A wide range of materials is suitable for the production of HXs. The main characteristics to consider are density, thermal conductivity, AM processability, and finally cost. The selection of the most suitable material is carried out based on the component requirements, the type of operating environment and the boundary conditions [31]. In particular, the AM metal alloys mainly used are stainless steel, employed for HXs operating at high temperatures and corrosive environments; Ni-based alloys and Titanium (Ti) alloys are used in the application at very high temperatures; Al alloys applied in fields where the main requirement is lightweight, and the operating temperatures don't exceed 250 °C; Copper (Cu) alloys are high suitable materials thanks to its high thermal conductivity but are not yet mature due to their poor processability via AM [127] and reaction with esters in oil [128]. A basic comparison between the principal materials used for the manufacturing of HXs is summarised in Table 6.

**Table 6**  
Comparison of general properties for the selected materials [129–131].

Material	Density [g/cm <sup>3</sup> ]	Specific Thermal Conductivity [W/mK]	Melting Point (°C)	AM Friendly (from 1, poor, to 10, excellent)	Powder Average Price (£/kg)
Aluminium	2.70	205	660	6	2.67
Stainless Steels	8.00	16	1530	10	2.53
Nickel	8.90	94	1453	8	25.86
Titanium	4.51	22	1670	9	44.89
Copper	8.96	401	1084	4	4.20

In the following sections, the characteristics of the main materials presented above are described.

### 6.1. Stainless steels

Stainless Steels have always been used in a wide range of industrial applications thanks to their excellent mechanical properties, corrosion resistance and relatively low costs [132]. Therefore, they are a good material candidate for the production of HXs. The challenges in the AM process of Stainless Steel have already been overcome by the scientific community and often additive components subjected to heat treatments possess superior properties compared to their conventional counterpart. Many studies have focused on the evaluation of microstructural, mechanical and corrosion properties of these alloys, and in particular, 316L austenitic stainless steel resulted in the most used and suitable for aeronautical and aerospace applications [133]. Many works on the processability of 316L via AM and in particular L-PBF are available. The typical microstructure deriving from an additive process for 316L is composed of elongated dendritic grains along the building plane. This particular microstructure gives superior mechanical properties to the as-built material. Revilla et al. [134] have shown excellent corrosion properties of 316L processed by AM, showing higher oxide stability than the conventional one and similar resistance. Furthermore, 316L has been demonstrated as suitable for the fabrication of thin features, by Yang et al. [135]. 316L is therefore a good candidate for the selection of the most suitable material for HXs. However, the high density of the material and the non-exceptional thermal properties must be considered. Consequently, this material and more generally the stainless steels are not ideal for the manufacture of HXs for aeroengines in aerospace applications but can be taken into consideration for other HX types in several industrial fields.

### 6.2. Ni-based alloys

Ni-based alloys are widely used in the aerospace field thanks to their superior mechanical properties at high and very high temperatures [136]. For this reason, they are also selected for the manufacturing of HXs. In particular, Inconel 625 and Inconel 718 are the most known Ni-based superalloys. Recent studies [137–139] have demonstrated the feasibility of features such as thin walls via these materials and the influence of AM process parameters. Consequently, given the great corrosive and wear properties of these alloys, Inconel 625 and Inconel 718 would be excellent candidates for guaranteeing superior properties to HXs. However, the continuing need to reduce the total weight of aircraft makes this material not suitable for manufacturing air to oil compact HXs, and they are mostly used in the hot stages of aero engines.

### 6.3. Ti alloys

The best-known Ti alloy used in various industrial sectors is the Ti6Al4V. It is a material with high strength, low density, high fracture toughness, excellent corrosion resistance and superior biocompatibility [140]. Originally, the Ti6Al4V alloy was developed for structural applications in the aerospace field as this light, but strong alloy allows a reduction of the weight of highly loaded structures maintaining the reliability of the structural components [140,141]. Current scientific research in the feasibility of thin-walled features has used Ti6Al4V in several studies as the processability and the influence of the optimal parameters on the microstructure, mechanical and thermal properties, and corrosive and fatigue performance has been assessed for some time. Recent studies, such as the work of Chen et al. [142] and Gockel et al. [143] focused on the analysis of the correlation between melt pool and thin features and the discovery of techniques for the tailoring of the microstructure and properties during the production of thin sections. In particular, Chen et al. [142] also focused on the evaluation of thermal phenomena that lead to the formation of residual stresses and the effects



on the final geometry of thin walls. The authors pointed out that during the fabrication of thin walls, deformations accumulate, causing the geometry to vary. The greater the height of the features, the greater the deviation from the nominal value. The critical point is the middle of the wall, with the deformation which then tends to stabilise up to an average value. Consequently, this material is a promising material for the construction of HXs.

#### 6.4. Cu alloys

Copper and its alloys are very suitable for heat transfer applications but present many challenges. They are sensitive to impurities and the AM printability is very low due to the high surface reflectivity and low laser absorption. Furthermore, the high thermal gradient can result in delamination and bending during the AM process [127,144]. Nevertheless, in the recent year, many attempts to investigate the manufacturability of AM of Cu alloys are registered, in particular for heat transfer applications. Several studies have employed Cu alloys with added alloying elements to reduce reflectivity and improve absorption properties. These investigations have focused on the additive manufacturing of different heat sink configurations and small-scale heat exchanger concepts. Subsequently, a comparative analysis was conducted to assess the performance of these printed structures in relation to their traditionally manufactured counterparts. [32,145]. Furthermore, AM of Cu alloys was implemented for high flux applications in the aerospace field. In the last decade, several studies [146] on a wide range of applications were reported, with particular interest in combustion chambers for liquid rocket engines [147,148]. AM of Cu alloys for aerospace offers the potential for lightweight, complex, and customized components with enhanced mechanical, thermal, and electrical properties. However, research, testing, and validation to ensure the suitability and performance of AM copper alloy parts for specific aerospace applications are still ongoing.

#### 6.5. Al alloys

Al alloys are most commonly used for air-oil HXs due to their high thermal conductivity, low density, and low cost relative to other metallic materials [136]. Al alloys are available in wrought and cast form and can be divided into two groups, heat treatable and not [149,150]. In AM, the most suitable Al powders are usually based on cast alloys due to similar material properties necessary for both AM and casting processes, such as castability, low shrinkage, and no solidification or liquation cracking. In particular, the use of near-eutectic metal alloys increases processability through AM and allows for a reduction of defects such as porosity and segregations thanks to greater fluidity and therefore better management of the melt pool solidification phase. Moreover, given the complex chemical composition used today, a near-eutectic alloy allows a better homogenisation of the alloying elements and greater stability of the matrix and the constituent phases [151,152]. In contrast, wrought alloys are not suitable for AM as they require a long solidification range which can generate hot cracking [153]. The interaction between each alloying element of an Al matrix material determines the response and the final properties of the alloy [154].

Current challenges with Al processed via AM include the material's high reflectivity [155] and thermal conductivity which can result in high levels of porosity. In L-PBF the most common Al alloys are near eutectic Al-Si alloys such as AlSi10Mg, AlSi12, A357 and A356 [156]. New Al alloys to be considered as have been customised for L-PBF processes as a variant of casting alloys are Airbus Scalmalloy® and Aeromet A20X™. The chemical composition of these alloys is described in Table 7.

AlSi10Mg is a hypoeutectic casting grade alloy. The Si content, see Table 7, allows for the solidification cracking phenomenon to be controlled with the solidification range being refined to a window of just 30 °C [156,160]. Si has high absorptivity and low reflectivity in

**Table 7**

Chemical composition (wt.%) of Al alloys [157–159].

	AlSi10Mg	A20X™	Scalmalloy®
Al	Balance	Balance	Balance
Si	9.00–11.00	<0.10	<0.40
Mg	0.25–0.45	0.20–0.33	4.00–4.90
Cu	<0.05	4.20–5.00	<0.10
Ti	<0.15	3.00–3.85	<0.15
Fe	<0.25	<0.08	<0.40
Zn	<0.10	–	<0.25
Mn	<0.45	–	0.30–0.80
Pb	<0.05	–	–
Ni	<0.05	–	–
Sn	<0.05	–	–
B	–	1.25–1.55	–
Ag	–	0.60–0.90	–
Sc	–	–	0.60–0.80
Zr	–	–	0.20–0.50

comparison to Al, improves molten Al fluidity, lowers solidification shrinkage, and lowers the coefficient of thermal expansion, all of which improve the AM processability of Al [161–163]. AlSi10Mg can consistently produce material with a density above 99 % with a variety of parameters. The alloy gains much of its strength from the ultrafine microstructure formed by the rapid solidification SLM processing and from needle-like  $\beta'$ -Mg<sub>2</sub>Si precipitates. The properties of AlSi10Mg when produced by SLM, have higher strength than cast or wrought equivalents due to the ultrafine structure and maintain a good UTS at elevated temperatures. It has therefore gained applications in aerospace as a low-cost equivalent to Ti alloys, and in motorsport and automotive to allow for greater design freedoms in HXs and engine block components. AlSi10Mg is commonly heat-treated using the standardised T6 process comprising of solution heat treating followed by artificial ageing [164,165]. In particular, Aboulkhair et al. [164] demonstrate the effect of the T6 treatment on additively manufactured AlSi10Mg, highlighting a decrease of the ultimate tensile strength (UTS) in return for an increase in ductility.

A20X™ has another designation, A205, which is a metal matrix composite based on an Al-Cu system with the addition of Ti and boron (B), present as the ceramic, Ti diboride (TiB<sub>2</sub>), as represented in Table 7 [166,167]. The addition of TiB<sub>2</sub> changes the alloy to a mass feeding mechanism which allows for homogenous grain formation across the material, negating the need for interdendritic feeding. The presence of the TiAl<sub>3</sub> phase in A20X™ alloy yields a grain refinement effect, resulting in the formation of fine equiaxed  $\alpha$ -Al grains that nucleate around TiAl<sub>3</sub> particles. This phenomenon contrasts with the formation of coarse columnar grains, enhancing the mechanical properties of the material [166,168]. Furthermore, TiB<sub>2</sub> has a grain refinement effect, to a lesser extent than TiAl<sub>3</sub>, but is suspected to restrict the growth of the grains which leads to an ultrafine homogenous structure with high UTS at room temperature. A20X™ rivals 7000 series alloys in strength and preserves good ductility, while also retaining UTS at elevated temperatures up to 250 °C better than other AM Al-alloys.

Scalmalloy® is an Al, magnesium (Mg), scandium (Sc), and zirconium (Zr) alloy, see Table 7, based on the 5000 series of Al-alloys [169]. It has a bimodal microstructure with fine equiaxed grains separated by coarser columnar grains, where the addition of Sc to the hyper eutectic point (eutectic at 0.4–0.55 wt%) provides grain refinement and an increase in strength, as well as the addition of Mg, provided solid solution hardening in the form of Al<sub>3</sub>Mg<sub>5</sub> precipitate due to the lack of Si presence [159,170]. Sc is an extremely expensive element with a single source which translates into a significantly more expensive alloy to the point where it no longer competes effectively with Ti-alloys. Furthermore, the elevated temperature properties, while still acceptable, are not as impressive as either AlSi10Mg or A20X™.

### 6.5.1. Mechanical properties

The mechanical properties of additive components are still a subject of investigation due to the distinctive columnar microstructure resulting from the L-PBF process. Specifically, the absence of standards poses a challenge in accurately characterising materials fabricated through AM techniques. Consequently, the scientific community has tried to respond to the need for analysis and explanation of mechanical properties using several methods. Several studies have analysed the effect of the building direction on tensile mechanical properties. In particular, Ponnusamy et al. [171] collected several studies highlighting a horizontal building direction as the best configuration. Read et al. [172] on the other hand, together with the mechanical properties of the AlSi10Mg alloy using the optimal parameters obtained through an experimental campaign, also evaluated the creep properties at high temperatures. In particular, according to the authors, the build direction does not seem to influence the tensile or creep resistance of the material, achieving higher performance than the conventional counterpart.

A comparative evaluation of the mechanical properties between additively manufactured and conventionally cast materials has been collected and presented in Table 8.

### 6.5.2. Tribology and corrosion

Nowadays, the corrosion protection mechanism for AM material holds significant importance. Surface roughness, microstructure, and post thermal treatment are essential to increase the corrosion property of a material. A high-quality surface or a surface treatment of polishing can help to decrease the corrosion rate in the air and marine environment, but it is difficult to achieve for highly complex geometries and internal features [177,178]. Regarding the post thermal treatments, different temperatures and times, together with the type of thermal treatment (solution, ageing, etc.) attribute different properties and therefore different corrosion performances [179,180]. Extensive research efforts have been dedicated to the investigation of AlSi10Mg alloy [181–183] as it is the most widely used and studied Al alloy, while for the other Al alloys, few studies have been discovered [184].

Other mechanisms for corrosion protection are available for AM materials. Conversion coating is used to achieve the full protective properties of Al alloys. Chromate conversion coatings (CCCs) have been commonly applied as a surface finishing process, but they soon have to be replaced due to the toxic and carcinogenic effects of hexavalent chromium compounds. Recently, a new conversion coating has been developed, known as Trivalent Chromium Processes (TCP) [185,186]. Also, another mechanism called Layered double hydroxides (LDHs) seems to be a new and healthy alternative to the chromate-based coating [187]. Organic coatings provide protection to the surface thanks to the pigments in the coating, acting as a barrier between the material and the external environment. For example, polymers such as polypyrrole (PPy), polythiophene (PTh) and polyaniline (PANI) are often used to generate organic coatings to prevent corrosion of Al and its alloys [188]. Besides, silica-based organic–inorganic hybrid nanocomposite films have been developed using sol–gel methods to generate coating against corrosive environments [189,190]. Finally, Al anodising is a process that uses electrochemical reactions to generate a protective oxidised layer on the surface of the metal materials. Plasma Electrolytic Oxidation (PEO) [191] is the most common and used in recent years. In particular, this

last coating is an eco-friendly treatment that allows the formation of an Alumina oxide ( $Al_2O_3$ ) coating that guarantees stable and long-term superior properties of resistance to corrosion and wear.

### 6.5.3. Influence of post thermal treatments

The post thermal treatments of Al alloys are performed to eliminate various manufacturing defects and impurities, to obtain recrystallisation and to improve the mechanical properties and the behaviour of the material during the life cycle. Al alloys are generally subjected to solution and quenching treatments, followed by artificial ageing treatments. The solution treatment involves maintaining the material at a high temperature to allow the diffusion of the alloying elements in the matrix. It is usually followed by water quenching which involves rapid cooling in order to obtain an oversaturated structure of alloying elements and can significantly impact the success of the treatment. Failure to control factors, such as the temperature and agitation of the hardening medium, the immersion speed, and the orientation of the part, can result in the formation of internal bubbles caused by pore growth and lead to permanent deformations. Finally, the ageing treatment consists of a medium-long permanence of the material and medium–low temperatures to allow the precipitation of the strengthening phases and increase the final mechanical properties of the component. The most common post thermal treatments of Al alloys are T6 and T7 heat treatments, described in Fig. 12. In particular, the HT T7 involves an ageing step characterised by higher temperature and shorter duration compared to the HT T6, in order to achieve a significant grain growth increasing the material's creep resistance.

Limited information on the properties of materials made through AM after thermal treatments are available in the literature. These have been summarised in Table 9. While for the AlSi10Mg and A20X™ alloys, the standard thermal treatments are known for the corresponding conventional materials made by casting, for the Scalmalloy® alloy they do not exist. Consequently, ad hoc thermal treatments have been studied for this alloy, and the proposed thermal treatment consists of a single step of 4 h at a temperature of 325 °C [193], considered in Table 9, or a hot isostatic pressing (HIP). A recent study published by Kuo et al. [194] confirmed 325 °C as the ideal thermal treatment temperature to favour the formation of  $Al_3Sc$  precipitates which give superior properties to the heat-treated alloy.

Numerous studies are focusing on the optimisation of post-additive thermal treatments for numerous AM metal alloys including Al alloys [196] and particular attention is focused on the study of the effects of standard treatments [197–199]. Among the conventional thermal treatment suitable for the AlSi10Mg alloy produced with additive processes, stress relief is the most used in the industrial field. The treatment is usually carried out at a temperature of around 300 °C for a period of 2 h, and guarantees better ductility and resistance to fatigue, with deterioration of the mechanical properties [200].

Many studies in [164,201] highlighted the unsuitability of the standard post thermal treatments for L-PBF Al alloys as it leads to a decrease in the mechanical properties of the material such as hardness and tensile strength. Consequently, the evaluation of new customised post thermal treatment is ongoing [202,203] to assess the ideal thermal cycle for tailoring the microstructure and maximising the mechanical performance of Al alloys.

**Table 8**  
Differences in mechanical properties of additively and cast Al alloy [158,173–176].

Material	AlSi10Mg		A20X™		Scalmalloy®			
	As-built	Cast	As-built	Cast	As-built	Cast		
Mechanical Properties	YS at RT	MPa	230	230	385	220	306	–
	UTS at RT	MPa	460	270	410	370	334	–
	Elongation (RT)	%	6.3	2.5	15	20	12	–
	Fatigue Strength at $T_{room}$	MPa	110	76	150	120	–	–
	Young's Modulus (RT)	GPa	66	71	74	71	65	–

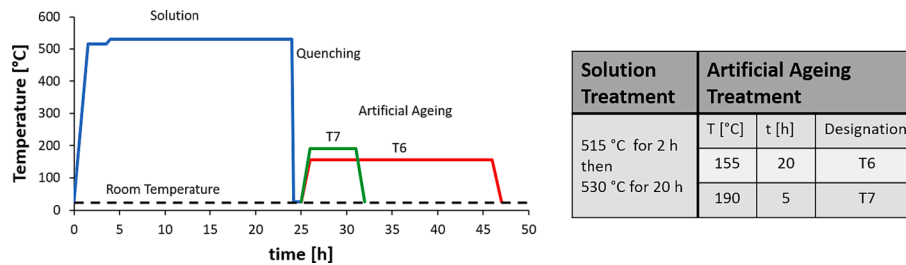

Fig. 12. Conventional thermal treatments for Al alloy produced by casting following the ASM handbook standard [192].

Table 9

Mechanical properties of Al alloys fabricated by L-PBF, differences between as-built and heat-treated materials [158,173–176,195].

Material Configuration	AlSi10Mg		A20X™		Scalmalloy®			
	As-built	HT T6	As-built	HT T7	As-built	HT		
Max Operating Temp		°C	200		230		250	
YS at RT		MPa	230	250	385	445	306	480
YS at 200 °C		MPa	–	–	–	311	–	139
YS at 230 °C		MPa	–	–	–	215	–	71
UTS at RT		MPa	460	310	410	511	334	530
UTS at 200 °C		MPa	–	–	–	331	–	163
UTS at 250 °C		MPa	–	–	–	224	–	78
Elongation (RT)		%	6.3	11	15	11	12	13
Young’s Modulus (RT)		GPa	66	69	74	79	65	70

7. Conclusions

Heat Exchangers are typically produced through conventional manufacturing strategies. Additive Manufacturing and in particular L-PBF allow the generation of complex geometries for mass production of components with short lead time. Additive Manufacturing, with the help of advanced tools such as Topological optimisation and CFD modelling, is able to optimise the shape guaranteeing lighter and more performant Heat Exchangers, tailoring the mechanical and corrosion properties of the components. Academia and industry are currently confronting the challenges in the design and production of new generations of Heat Exchangers. The objective of this review was to provide a comprehensive overview of the current status and challenges in the design and manufacturing of new heat exchangers using Additive Manufacturing technology. In particular, the ability of Additive Manufacturing to produce thin complex features could revolutionise the aerospace sector by generating compact Heat exchangers, with high efficiency and less weight, but is not yet mature. L-PBF as a winning strategy is a much-debated topic in the scientific field due to many technological limits that still need to be overcome. First, the optimisation of process parameters for the manufacture of a leak-proof with thin-walled features has yet to be reliable and repeatable. Moreover, a thorough understanding of the effects of L-PBF process parameters on the surface roughness, microstructure and density of fabricated Heat Exchangers has not yet been achieved. Furthermore, a careful analysis for the selection of suitable materials for L-PBF is still necessary to manufacture high quality components, guaranteeing repeatability, reproducibility, and traceability. The principal material candidates were reviewed, and the AM feasibility was evaluated. Particular attention was focused on the most common material, high-strength Aluminium alloys, which maintain high mechanical strength even at high temperatures and severe environments. Microstructure, mechanical properties and the influence of post thermal treatments on the performance of these alloys produced using L-PBF were provided.

Declaration of Competing Interest

The authors declare that they have no known competing financial interests or personal relationships that could have appeared to influence

the work reported in this paper.

Data availability

No data was used for the research described in the article.

Acknowledgements

This work is part of the C-AM AOHE project funded by the European Union’s Horizon H2020-CS2-CFP08-2018-01 research and innovation program under grant agreement No. 831880. This work was also supported in part by the EPSRC Centre for Doctoral Training in Topological Design, funded by the UK Engineering and Physical Sciences Research Council (grant EP/S02297X/1) based at the University of Birmingham.

References

- [1] B. Sundén, J. Fu, Chapter 6 - aerospace heat exchangers, in: *Heat Transfer in Aerospace Applications*, Academic Press, 2017, pp. 89–115.
- [2] Meggitt, Advanced Thermal Systems Technology. Step-changing technology for next generation energy efficient ultra-high bypass ratio (UHBR) aero engines, <https://www.meggitt.com/insights/step-changing-technology-for-the-next-generation-of-aero-engines/> (accessed on 15 June 2022).
- [3] D. Saltzman, M. Bichnevicius, S. Lynch, T.W. Simpson, E.W. Reutzel, C. Dickman, R. Martukanitz, Design and evaluation of an additively manufactured aircraft heat exchanger, *Appl. Therm. Eng.* 138 (2018) 254–263.
- [4] M. William, A. Muley, J. Bolla, H. Strumpf, *Advanced Heat Exchanger Technology for Aerospace Applications*, SAE International, 2008.
- [5] C. Balaji, B. Srinivasan, S. Gedupudi, Chapter 7 - heat exchangers, in: C. Balaji, B. Srinivasan, S. Gedupudi (Eds.), *Heat Transfer Engineering*, Academic Press, 2021, pp. 199–231.
- [6] K. Kasim, A. Muley, M. Stoia, F. Ladeinde, Advanced heat transfer devices for aerospace applications, *ASME 2017 International Mechanical Engineering Congress and Exposition Vol. 8* (2017).
- [7] M. Williams, A. Muley, J. Bolla, H. Strumpf, *Advanced Heat Exchanger Technology for Aerospace Applications*, SAE International, 2008.
- [8] D. Southall, R. Le Pierres, S.J. Dewson, Design considerations for compact heat exchangers, in: *Proceedings of ICAPP*, Vol. 8, ICAPP, 2008, pp. 8–12.
- [9] P. Moorthy, A.N. Oumer, M. Ishak, Experimental investigation on effect of fin shape on the thermal-hydraulic performance of compact fin-and-tube heat exchangers, *IOP Conf. Ser.: Mater. Sci. Eng.* 318 (2018), 012070.
- [10] M.I.N. Ma’arof, G.T. Chala, H. Husain, M.S.S. Mohamed, Influence of fins designs, geometries and conditions on the performance of a plate-fin heat exchanger-experimental perspective, *J. Mech. Eng. Sci.* 13 (2019) 4368–4379.
- [11] M. Göltas, B. Gürel, A. Kecebas, V.R. Akkaya, O.V. Güler, Improvement of thermo-hydraulic performance with plate surface geometry for a compact plate

- heat exchanger manufactured by additive manufacturing, *Int. J. Heat Mass Transf.* 188 (2022), 122637.
- [12] A. Menéndez Pérez, C. Fernández-Aballí Altamirano, R. Borrajo Pérez, Parametric analysis of the influence of geometric variables of vortex generators on compact louver fin heat exchangers, *Therm. Sci. Eng. Prog.* 27 (2022), 101151.
- [13] J. Yao, A review of industrial heat exchange optimization, *IOP Conf. Ser.: Earth Environ. Sci.* 108 (2018), 042036.
- [14] Mott, 3D Printed Heat Exchangers, <https://mottcorp.com/product/3d-printed-products/3d-printed-heat-exchangers/> (accessed on 16 February 2022).
- [15] Stratatsy, Advancing Thermal Management with Additive Manufacturing, [https://www.stratatsydirect.com/-/media/files/direct/white-papers/thermal-m-management-white-paper\\_web.pdf](https://www.stratatsydirect.com/-/media/files/direct/white-papers/thermal-m-management-white-paper_web.pdf) (accessed on 16 February 2022).
- [16] Hyperganic, The Heat Exchanger, Algorithmic Engineering of heat exchangers, <https://www.hyperganic.com/press-and-stories/2/> (accessed on 20 June 2023).
- [17] I. Kaur, P. Singh, Critical evaluation of additively manufactured metal lattices for viability in advanced heat exchangers, *Int. J. Heat Mass Transf.* 168 (2021), 120858.
- [18] T. Maconachie, M. Leary, B. Lozanovski, X. Zhang, M. Qian, O. Faruque, M. Brandt, SLM lattice structures: properties, performance, applications and challenges, *Mater. Des.* 183 (2019), 108137.
- [19] H.N.G. Wadley, D.T. Queheillat, Thermal applications of cellular lattice structures, *Mater. Sci. Forum* 539–543 (2007) 242–247.
- [20] K.J. Maloney, K.D. Fink, T.A. Schaedler, J.A. Kolodziejska, A.J. Jacobsen, C. S. Roper, Multifunctional heat exchangers derived from three-dimensional micro-lattice structures, *Int. J. Heat Mass Transf.* 55 (2012) 2486–2493.
- [21] N. Lebaal, A. Settari, S. Roth, S. Gomes, Conjugate heat transfer analysis within in lattice-filled heat exchanger for additive manufacturing, *Mech. Adv. Mater. Struct.* (2020) 1–9.
- [22] L.-Y. Chen, S.-X. Liang, Y. Liu, L.-C. Zhang, Additive manufacturing of metallic lattice structures: unconstrained design, accurate fabrication, fascinated performances, and challenges, *Mater. Sci. Eng. R. Rep.* 146 (2021), 100648.
- [23] D. Jafari, W.W. Wits, The utilization of selective laser melting technology on heat transfer devices for thermal energy conversion applications: a review, *Renew. Sustain. Energy Rev.* 91 (2018) 420–442.
- [24] J.Y. Ho, K.C. Leong, T.N. Wong, Additively-manufactured metallic porous lattice heat exchangers for air-side heat transfer enhancement, *Int. J. Heat Mass Transf.* 150 (2020), 119262.
- [25] J. Noronha, M. Qian, M. Leary, E. Kyriakou, M. Brandt, Hollow-walled lattice materials by additive manufacturing: design, manufacture, properties, applications and challenges, *Curr. Opin. Solid State Mater. Sci.* 25 (2021), 100940.
- [26] I.A. 52900, Additive manufacturing - General principles - Fundamental and vocabulary, 2021.
- [27] I. Gibson, D. Rosen, B. Stucker, M. Khorasani, Binder jetting, in: I. Gibson, D. Rosen, B. Stucker, M. Khorasani (Eds.), *Additive Manufacturing Technologies*, Springer International Publishing, Cham, 2021, pp. 237–252.
- [28] T. Vaneker, A. Bernard, G. Moroni, I. Gibson, Y. Zhang, Design for additive manufacturing: framework and methodology, *CIRP Ann.* 69 (2020) 578–599.
- [29] A. Hehr, M. Norfolk, A comprehensive review of ultrasonic additive manufacturing, *Rapid Prototyp. J.* 26 (2020) 445–458.
- [30] NasaJPL, Ultrasonic Welding Makes Parts for NASA Missions, *Commercial Industry*, 2021, <https://www.jpl.nasa.gov/news/ultrasonic-welding-makes-parts-for-nasa-missions-commercial-industry> (accessed on 04 November 2022).
- [31] E. Klein, J. Ling, V.C. Aute, Y. Hwang, R. Radermacher, A review of recent advances in additively manufactured heat exchangers, 2018.
- [32] J.R. McDonough, A perspective on the current and future roles of additive manufacturing in process engineering, with an emphasis on heat transfer, *Therm. Sci. Eng. Prog.* 19 (2020), 100594.
- [33] I. Kaur, P. Singh, State-of-the-art in heat exchanger additive manufacturing, *Int. J. Heat Mass Transf.* 178 (2021), 121600.
- [34] S.A. Niknam, M. Mortazavi, D. Li, Additively manufactured heat exchangers: a review on opportunities and challenges, *Int. J. Adv. Manuf. Technol.* 112 (2021) 601–618.
- [35] M. Leary, Chapter 11 - powder bed fusion, in: M. Leary (Ed.), *Design for Additive Manufacturing*, Elsevier, 2020, pp. 295–319.
- [36] S. Rahmati, 10.12 - Direct rapid tooling, in: S. Hashmi, G.F. Batalha, C.J. Van Tyne, B. Yilbas (Eds.), *Comprehensive Materials Processing*, Elsevier, Oxford, 2014, pp. 303–344.
- [37] X. Gong, T. Anderson, K. Chou, Review on powder-based electron beam additive manufacturing technology, *Manuf. Rev.* 1 (2014) 2.
- [38] GEAdditive, EBM MACHINE SOLUTIONS, <https://www.ge.com/additive/additive-manufacturing/machines/ebm-machines> (accessed on 23 February 2022).
- [39] M. Galati, L. Iuliano, A literature review of powder-based electron beam melting focusing on numerical simulations, *Addit. Manuf.* 19 (2018) 1–20.
- [40] M. AM, Unrealised potential: The story and status of Electron Beam Powder Bed Fusion, 2020.
- [41] T.D. Ngo, A. Kashani, G. Imbalzano, K.T.Q. Nguyen, D. Hui, Additive manufacturing (3D printing): a review of materials, methods, applications and challenges, *Compos. B Eng.* 143 (2018) 172–196.
- [42] A.B. Badiru, V.V. Valencia, D. Liu, *Additive Manufacturing Handbook: Product Development for the Defense Industry*, 1st edition, CRC Press, 2017.
- [43] A. Gebhardt, Layer manufacturing processes, in: A. Gebhardt (Ed.), *Understanding Additive Manufacturing*, Hanser, 2011, pp. 31–63.
- [44] H. Shipley, D. McDonnell, M. Culleton, R. Coull, R. Lupoi, G. O'Donnell, D. Trimble, Optimisation of process parameters to address fundamental challenges during selective laser melting of Ti-6Al-4V: a review, *Int. J. Mach. Tool Manuf.* 128 (2018) 1–20.
- [45] W.E. King, A.T. Anderson, R.M. Ferencik, N.E. Hodge, C. Kamath, S.A. Khairallah, A.M. Rubenchik, Laser powder bed fusion additive manufacturing of metals; physics, computational, and materials challenges, *Appl. Phys. Rev.* 2 (2015), 041304.
- [46] E. Santecchia, S. Spigarelli, M. Cabibbo, Material reuse in laser powder bed fusion: side effects of the laser–metal powder interaction, *Metals* 10 (2020), 341.
- [47] S. Sun, M. Brandt, M. Easton, 2 - Powder bed fusion processes: an overview, in: M. Brandt (Ed.), *Laser Additive Manufacturing*, Woodhead Publishing, 2017, pp. 55–77.
- [48] I. Yadroitsev, I. Yadroitsava, A. Du Plessis, 2 - Basics of laser powder bed fusion, in: I. Yadroitsev, I. Yadroitsava, A. du Plessis, E. MacDonald (Eds.), *Fundamentals of Laser Powder Bed Fusion of Metals*, Elsevier, 2021, pp. 15–38.
- [49] PrimaAdditive, Technologies - Powder bed Fusion, <https://www.primaadditive.com/it/tecnologie/powder-bed-fusion> (accessed on 23 February 2022).
- [50] AM Metal, SLM Solutions launches 12-laser metal Additive Manufacturing machine, <https://www.metal-am.com/slm-solutions-launches-12-laser-metal-additive-manufacturing-machine/> (accessed on 23 February 2022).
- [51] Additive Industries, A New Metal Additive Manufacturing Era | The MetalFABG2, <https://www.additiveindustries.com/metalfabg2> (accessed on 05 April 2023), 2022.
- [52] G.V. de Leon Nope, L.I. Perez-Andrade, J. Corona-Castuera, D.G. Espinosa-Arbelaiz, J. Muñoz-Saldaña, J.M. Alvarado-Orozco, Study of volumetric energy density limitations on the IN718 mesostructure and microstructure in laser powder bed fusion process, *J. Manuf. Process.* 64 (2021) 1261–1272.
- [53] S. Chowdhury, N. Yadaiah, C. Prakash, S. Ramakrishna, S. Dixit, L.R. Gupta, D. Buddhi, Laser powder bed fusion: a state-of-the-art review of the technology, materials, properties & defects, and numerical modelling, *J. Mater. Res. Technol.* 20 (2022) 2109–2172.
- [54] J.C. Snyder, K.A. Thole, Effect of additive manufacturing process parameters on turbine cooling, in: *ASME Turbo Expo 2019: Turbomachinery Technical Conference and Exposition*, Vol. Volume 5B: Heat Transfer, 2019.
- [55] J.C. Snyder, K.A. Thole, Tailoring surface roughness using additive manufacturing to improve internal cooling, *J. Turbomach.* 142 (2020).
- [56] J.C. Snyder, K.A. Thole, Understanding laser powder bed fusion surface roughness, *J. Manuf. Sci. Eng.* 142 (2020).
- [57] J.P. Oliveira, A.D. LaLonde, J. Ma, Processing parameters in laser powder bed fusion metal additive manufacturing, *Mater. Des.* 193 (2020), 108762.
- [58] M.M. Aslam Bhutta, N. Hayat, M.H. Bashir, A.R. Khan, K.N. Ahmad, S. Khan, CFD applications in various heat exchangers design: a review, *Appl. Therm. Eng.* 32 (2012) 1–12.
- [59] B. Sundén, Computational fluid dynamics in research and design of heat exchangers, *Heat Transfer Eng.* 28 (2007) 898–910.
- [60] C. Abeykoon, Compact heat exchangers – design and optimization with CFD, *Int. J. Heat Mass Transf.* 146 (2020), 118766.
- [61] A. Jamal, R. Siahputra, Heat exchanger control based on artificial intelligence approach, *Int. J. Appl. Eng. Res. (IJAER)* 11 (2016) 9063–9069.
- [62] J. Krzywanski, A general approach in optimization of heat exchangers by bio-inspired artificial intelligence methods, *Energies* 12 (2019), 4441.
- [63] M. Mohanraj, S. Jayaraj, C. Muraleedharan, Applications of artificial neural networks for thermal analysis of heat exchangers – a review, *Int. J. Therm. Sci.* 90 (2015) 150–172.
- [64] M. Sridharan, Chapter 15 - applications of artificial intelligence techniques in heat exchanger systems, in: L. Pekař (Ed.), *Advanced Analytic and Control Techniques for Thermal Systems with Heat Exchangers*, Academic Press, 2020, pp. 325–334.
- [65] M. Ghalandari, M. Irandoost Shahrestani, A. Maleki, M. Safdari Shadloo, M. El Haj Assad, Applications of intelligent methods in various types of heat exchangers: a review, *J. Therm. Anal. Calorim.* 145 (2021) 1837–1848.
- [66] J. Zhu, H. Zhou, C. Wang, L. Zhou, S. Yuan, W. Zhang, A review of topology optimization for additive manufacturing: status and challenges, *Chin. J. Aeronaut.* 34 (2021) 91–110.
- [67] E. Dalpadulo, F. Gherardini, F. Pini, F. Leali, Integration of topology optimisation and design variants selection for additive manufacturing-based systematic product redesign, *Appl. Sci.* 10 (2020), 7841.
- [68] K. Salonitis, S.A. Zarban, Redesign optimization for manufacturing using additive layer techniques, *Proc. CIRP* 36 (2015) 193–198.
- [69] COMSOL, Comparing Optimization Methods for a Heat Sink Design for 3D Printing, <https://www.comsol.com/blogs/comparing-optimization-methods-for-a-heat-sink-design-for-3d-printing/> (accessed on 23 February 2022), 2019.
- [70] E.M. Dede, Multiphysics topology optimization of heat transfer and fluid flow systems, in: *Proceedings of the COMSOL Users Conference*, 2009.
- [71] R.P.P. da Silva, M.V.V. Morteau, K.V. de Paiva, L.E. Beckedorff, J.L.G. Oliveira, F. G. Brandão, A.S. Monteiro, C.S. Carvalho, H.R. Oliveira, D.G. Borges, V. L. Chastinet, Thermal and hydrodynamic analysis of a compact heat exchanger produced by additive manufacturing, *Appl. Therm. Eng.* 193 (2021), 116973.
- [72] V.K. Patel, V.J. Savsani, M.A. Tawhid, Thermal Design and Optimization of Heat Exchangers, in: *Thermal System Optimization*, Springer, 2019, pp. 33–98.
- [73] H. Moon, D.J. McGregor, N. Miljkovic, W.P. King, Ultra-power-dense heat exchanger development through genetic algorithm design and additive manufacturing, *Joule* 5 (2021) 3045–3056.
- [74] Temisth, <http://temisth.com/> (accessed on 26 February 2022).
- [75] AddUp Global Additive Solutions, <https://addupsolutions.com/> (accessed on 26 February 2022).
- [76] Sogclair, <https://sogclair.com/> (accessed on 26 February 2022).



- [77] Temisth, AddUp, Sogclair, HEWAM – Heat Exchanger with Additive Manufacturing, 2019, <http://temisth.com/hewam-heat-exchanger-with-additive-manufacturing/> (accessed on 26 February 2022).
- [78] F. Feppon, G. Allaire, C. Dapogny, P. Jolivet, Body-fitted topology optimization of 2D and 3D fluid-to-fluid heat exchangers, *Comput. Methods Appl. Mech. Eng.* 376 (2021), 113638.
- [79] T. Dixit, E. Al-Hajri, M.C. Paul, P. Nithiarasu, S. Kumar, High performance, microarchitected, compact heat exchanger enabled by 3D printing, *Appl. Therm. Eng.* 210 (2022), 118339.
- [80] A. Muley, M. Stoia, D. Van Affelen, V. Reddy, V. Duggirala, S. Locke, Recent advances in thin-wall additively manufactured heat exchangers, in: *ASME 2021 International Mechanical Engineering Congress and Exposition, Vol. Volume 2A: Advanced Manufacturing*, 2021.
- [81] M. Mani, P. Witherell, *Design Rules for Additive Manufacturing: Literature Review and Research Categorization*, 2017.
- [82] Z. Wu, S.P. Narra, A. Rollett, Exploring the fabrication limits of thin-wall structures in a laser powder bed fusion process, *Int. J. Adv. Manuf. Technol.* 110 (2020) 191–207.
- [83] C. Tan, S. Li, K. Essa, P. Jamshidi, K. Zhou, W. Ma, M.M. Attallah, Laser Powder Bed Fusion of Ti-rich TiNi lattice structures: Process optimisation, geometrical integrity, and phase transformations, *Int. J. Mach. Tool Manuf.* 141 (2019) 19–29.
- [84] H. Hassanin, L. Finet, S.C. Cox, P. Jamshidi, L.M. Grover, D.E.T. Shepherd, O. Addison, M.M. Attallah, Tailoring selective laser melting process for titanium drug-delivering implants with releasing micro-channels, *Addit. Manuf.* 20 (2018) 144–155.
- [85] B. Gutmann, M. Köckinger, G. Glotz, T. Ciaglia, E. Slama, M. Zdravec, S. Pfanner, M.C. Maier, H. Gruber-Wölfler, C. Oliver Kappe, Design and 3D printing of a stainless steel reactor for continuous difluoromethylations using fluoroform, *React. Chem. Eng.* 2 (2017) 919–927.
- [86] L.W. Hunter, D. Brackett, N. Brierley, J. Yang, M.M. Attallah, Assessment of trapped powder removal and inspection strategies for powder bed fusion techniques, *Int. J. Adv. Manuf. Technol.* 106 (2020) 4521–4532.
- [87] A.V. Parmuzina, O.V. Kravchenko, Activation of aluminium metal to evolve hydrogen from water, *Int. J. Hydrogen Energy* 33 (2008) 3073–3076.
- [88] Y. Wang, K. Xu, L. Li, Inhibition of the reaction between aluminium dust and water based on the HIM, *RSC Adv.* 7 (2017) 33327–33334.
- [89] Solukon, Depowdering Metals SFM-AT800-S, <https://www.solukon.de/en/d-epowdering-metal/sfm-at800-s/> (accessed on 11 May 2023).
- [90] Inert Technologies, 3D Printing Depowdering With Powdershield, <https://www.inertcorp.com/powdershield/> (accessed on 24 February 2022).
- [91] A.M. Metal, Powder removal: The Achilles heel of powder bed-based metal Additive Manufacturing, <https://www.metal-am.com/articles/powder-removal-in-powder-bed-based-metal-3d-printing/> (accessed on 24 February 2022).
- [92] A.S. Sabau, A. Bejan, D. Brownell, K. Gluesenkamp, B. Murphy, F. List, K. Carver, C.R. Schaich, J.W. Klett, Design, additive manufacturing, and performance of heat exchanger with a novel flow-path architecture, *Appl. Therm. Eng.* 180 (2020), 115775.
- [93] Aerospace & Defense Technology, Curing the Porosity Problem in Additive Manufacturing, <https://www.aerodefensetech.com/component/content/article/e/ad/features/articles/39675> (accessed on 26 February 2022).
- [94] A.M. Ralls, P. Kumar, P.L. Menezes, Tribological properties of additive manufactured materials for energy applications: a review, *Processes* 9 (2021) 31.
- [95] D. Saltzman, S. Lynch, Flow-field measurements in a metal additively manufactured offset strip fin array using laser Doppler velocimetry, *J. Fluids Eng.* 143 (2021).
- [96] D. Saltzman, S. Lynch, Overall pressure loss and heat transfer performance of additively manufactured offset strip fins used in compact heat exchangers, *J. Therm. Sci. Eng. Appl.* 14 (2022).
- [97] T.M. Baker, M.P. Manahan, S.P. Lynch, E.W. Reutzler, Effect of hydraulic diameter and surface roughness on additively-manufactured offset strip fin heat exchanger performance, in: *ASME 2022 Heat Transfer Summer Conference collocated with the ASME 2022 16th International Conference on Energy Sustainability, Vol. ASME 2022 Heat Transfer Summer Conference, 2022*.
- [98] K.A. Thole, S.P. Lynch, A.J. Wildgoose, Chapter Five - Review of advances in convective heat transfer developed through additive manufacturing, in: J. P. Abraham, J.M. Gorman, W. Minkowycz (Eds.), *Advances in Heat Transfer*, Vol. 53, Elsevier, 2021, pp. 249–325.
- [99] A. Geete, R. Pathak, Effect of surface roughness on the performance of heat exchanger, *SN Appl. Sci.* 1 (2019) 901.
- [100] L. Cao, J. Li, J. Hu, H. Liu, Y. Wu, Q. Zhou, Optimization of surface roughness and dimensional accuracy in LPBF additive manufacturing, *Opt. Laser Technol.* 142 (2021), 107246.
- [101] J. Jiang, Y. Ma, Path planning strategies to optimize accuracy quality, build time and material use in additive manufacturing: a review, *Micromachines* 11 (2020), 633.
- [102] O. Poncelet, M. Marteleur, C. van der Rest, O. Rigo, J. Adrien, S. Dancette, P. J. Jacques, A. Simar, Critical assessment of the impact of process parameters on vertical roughness and hardness of thin walls of AlSi10Mg processed by laser powder bed fusion, *Addit. Manuf.* 38 (2021), 101801.
- [103] C. Silbernagel, A. Aremu, I. Ashcroft, Using machine learning to aid in the parameter optimisation process for metal-based additive manufacturing, *Rapid Prototyp. J.* 26 (2019) 625–637.
- [104] C.K. Stimpson, J.C. Snyder, K.A. Thole, D. Mongillo, Scaling roughness effects on pressure loss and heat transfer of additively manufactured channels, *J. Turbomach.* 139 (2016).
- [105] R. Molaei, A. Fatemi, Fatigue design with additive manufactured metals: issues to consider and perspective for future research, *Proc. Eng.* 213 (2018) 5–16.
- [106] A.B. Spierings, T.L. Starr, K. Wegener, Fatigue performance of additive manufactured metallic parts, *Rapid Prototyp. J.* 19 (2013) 88–94.
- [107] J.W. Pegues, S. Shao, N. Shamsaei, N. Sanaei, A. Fatemi, D.H. Warner, P. Li, N. Phan, Fatigue of additive manufactured Ti-6Al-4V, Part I: the effects of powder feedstock, manufacturing, and post-process conditions on the resulting microstructure and defects, *Int. J. Fatigue* 132 (2020), 105358.
- [108] A.D. Brandão, J. Gumpinger, M. Gschweilt, C. Seyfert, P. Hofbauer, T. Ghidini, Fatigue properties of additively manufactured AlSi10Mg – surface treatment effect, *Proc. Struct. Integrity* 7 (2017) 58–66.
- [109] M. Pelegatti, D. Benasciutti, F. De Bona, A. Lanzutti, M. Magnan, J. Srnc Novak, E. Salvati, F. Sordetti, M. Sortino, G. Totis, E. Vaglio, On the factors influencing the elastoplastic cyclic response and low cycle fatigue failure of AISI 316L steel produced by laser-powder bed fusion, *Int. J. Fatigue* 165 (2022), 107224.
- [110] G.S.M. Martins, R.P.P.D. da Silva, L. Beckedorff, A.S. Monteiro, K.V. de Paiva, J.L. G. Oliveira, Fatigue performance evaluation of plate and shell heat exchangers, *Int. J. Press. Vessel. Pip.* 188 (2020), 104237.
- [111] C.-H. Yu, A. Leicht, R.L. Peng, J. Moverare, Low cycle fatigue of additively manufactured thin-walled stainless steel 316L, *Mater. Sci. Eng. A* 821 (2021), 141598.
- [112] N. Spignoli, G. Minak, Influence on fatigue strength of post-process treatments on thin-walled AlSi10Mg structures made by additive manufacturing, in: *Metals*, Vol. 13, 2023.
- [113] N. Ahmad, S. Shao, M. Seifi, N. Shamsaei, Additively manufactured IN718 in thin wall and narrow flow channel geometries: effects of post-processing and wall thickness on tensile and fatigue behaviors, *Addit. Manuf.* 60 (2022), 103264.
- [114] W. Faes, S. Lecompte, Z.Y. Ahmed, J. Van Bael, R. Salenbien, K. Verbeke, M. De Paepe, Corrosion and corrosion prevention in heat exchangers, *Corros. Rev.* 37 (2019) 131–155.
- [115] R. Siva, G. Mageshwaran, S. Kallat, J. Jeevahan, Experimental investigation on the effect of corrosion and erosion on the shell and tube-type heat exchanger, *Int. J. Ambient Energy* 42 (2021) 816–822.
- [116] P. Renner, S. Jha, Y. Chen, A. Raut, S.G. Mehta, H. Liang, A review on corrosion and wear of additively manufactured alloys, *J. Tribol.* 143 (2021).
- [117] Y. Liu, Y. Yang, D. Wang, A study on the residual stress during selective laser melting (SLM) of metallic powder, *Int. J. Adv. Manuf. Technol.* 87 (2016) 647–656.
- [118] L. Mugwagwa, I. Yadroitsava, N.W. Makoana, I. Yadroitsev, 9 - Residual stress in laser powder bed fusion, in: I. Yadroitsev, I. Yadroitsava, A. du Plessis, E. MacDonald (Eds.), *Fundamentals of Laser Powder Bed Fusion of Metals*, Elsevier, 2021, pp. 245–276.
- [119] S.-G. Chen, H.-J. Gao, Y.-D. Zhang, Q. Wu, Z.-H. Gao, X. Zhou, Review on residual stresses in metal additive manufacturing: formation mechanisms, parameter dependencies, prediction and control approaches, *J. Mater. Res. Technol.* 17 (2022) 2950–2974.
- [120] D. Xie, F. Lv, Y. Yang, L. Shen, Z. Tian, C. Shuai, B. Chen, J. Zhao, A review on distortion and residual stress in additive manufacturing, *Chin. J. Mech. Eng.: Addit. Manuf. Front.* 1 (2022), 100039.
- [121] H.M. Khan, Y. Karabulut, O. Kitay, Y. Kaynak, I.S. Jawahir, Influence of the post-processing operations on surface integrity of metal components produced by laser powder bed fusion additive manufacturing: a review, *Mach. Sci. Technol.* 25 (2021) 118–176.
- [122] C. Li, Z.Y. Liu, X.Y. Fang, Y.B. Guo, Residual stress in metal additive manufacturing, *Proc. CIRP* 71 (2018) 348–353.
- [123] A. Martin, M. San Sebastian, E. Gil, C.Y. Wang, S. Milenkovic, M.T. Pérez-Prado, C.M. Cepeda-Jiménez, Effect of the heat treatment on the microstructure and hardness evolution of a AlSi10MgCu alloy designed for laser powder bed fusion, *Mater. Sci. Eng. A* 819 (2021), 141487.
- [124] S. Papula, M. Song, A. Pateras, X.-B. Chen, M. Brandt, M. Easton, Y. Yagodzinskyy, I. Virkkunen, H. Hänninen, Selective laser melting of duplex stainless steel 2205: effect of post-processing heat treatment on microstructure, mechanical properties, and corrosion resistance, *Materials* 12 (2019), 2468.
- [125] C. Zitelli, P. Polgarait, A. Di Schino, Laser powder bed fusion of stainless steel grades: a review, *Metals* 9 (2019), 731.
- [126] H. Chen, C. Zhang, D. Jia, D. Wellmann, W. Liu, Corrosion Behaviors of Selective Laser Melted Aluminum Alloys: A Review, *Metals* 10 (2020) 102.
- [127] Q. Jiang, P. Zhang, Z. Yu, H. Shi, D. Wu, H. Yan, X. Ye, Q. Lu, Y. Tian, A review on additive manufacturing of pure copper, *Coatings* 11 (2021) 740.
- [128] M.H.N. Parameswaran, A. Anand, S.R. Krishnamurthy, A comparison of corrosion behavior of copper and its alloy in *Pongamia pinnata* oil at different conditions, *J. Energy* 2013 (2013), 932976.
- [129] The Engineering Toolbox, Solid, Liquid, and Gases - Thermal Conductivities, [https://www.engineeringtoolbox.com/thermal-conductivity-d\\_429.html](https://www.engineeringtoolbox.com/thermal-conductivity-d_429.html) (accessed on 27 February 2022).
- [130] Psyclops, Density of materials; <http://www.psyclops.com/tools/technotes/materials/density.html> (accessed on 27 February 2022).
- [131] MetalMiner, MetalMiner Prices: Price feeds, embedded forecasts, should-cost models, 2022.
- [132] A. Zadi-Maad, R. Rohib, A. Irawan, Additive manufacturing for steels: a review, *IOP Conf. Ser.: Mater. Sci. Eng.* Vol. 285 (2018), 012028.
- [133] N. Haghdadi, M. Laleh, M. Moyle, S. Primig, Additive manufacturing of steels: a review of achievements and challenges, *J. Mater. Sci.* 56 (2021) 64–107.
- [134] R.I. Revilla, M. Van Calster, M. Raes, G. Arroud, F. Andreatta, L. Pyl, P. Guillaume, I. De Graeve, Microstructure and corrosion behavior of 316L stainless steel prepared using different additive manufacturing methods: a

- comparative study bringing insights into the impact of microstructure on their passivity, *Corros. Sci.* 176 (2020), 108914.
- [135] Z. Yang, Y. Yu, Y. Wei, C. Huang, Crushing behavior of a thin-walled circular tube with internal gradient grooves fabricated by SLM 3D printing, *Thin-Walled Struct.* 111 (2017) 1–8.
- [136] B. Cantor, H. Assender, P. Grant, *Aerospace Materials*, CRC Press, 2015.
- [137] M. Karmuhilan, S. Kumanan, A review on additive manufacturing processes of Inconel 625, *J. Mater. Eng. Perform.* (2021).
- [138] A.N. Jinoop, C.P. Paul, S.K. Mishra, K.S. Bindra, Laser Additive Manufacturing using directed energy deposition of Inconel-718 wall structures with tailored characteristics, *Vacuum* 166 (2019) 270–278.
- [139] P.R. Gradl, D.C. Tinker, J. Ivester, S.W. Skinner, T. Teasley, J.L. Bili, Geometric feature reproducibility for laser powder bed fusion (L-PBF) additive manufacturing with Inconel 718, *Addit. Manuf.* 47 (2021), 102305.
- [140] S. Liu, Y.C. Shin, Additive manufacturing of Ti6Al4V alloy: a review, *Mater. Des.* 164 (2019), 107552.
- [141] E. Uhlmann, R. Kersting, T.B. Klein, M.F. Cruz, A.V. Borille, Additive manufacturing of titanium alloy for aircraft components, *Proc. CIRP* 35 (2015) 55–60.
- [142] C. Chen, Z. Xiao, H. Zhu, X. Zeng, Deformation and control method of thin-walled part during laser powder bed fusion of Ti–6Al–4V alloy, *Int. J. Adv. Manuf. Technol.* 110 (2020) 3467–3478.
- [143] J. Gockel, J. Fox, J. Beuth, R. Hafley, Integrated melt pool and microstructure control for Ti–6Al–4V thin wall additive manufacturing, *Mater. Sci. Technol.* 31 (2015) 912–916.
- [144] T.J. Horn, D. Gamzina, Additive manufacturing of copper and copper alloys, in: D. L. Bourell, W. Frazier, H. Kuhn, M. Seifi (Eds.), *Additive Manufacturing Processes*, Vol. 24, ASM International, 2020.
- [145] X. Tang, X. Chen, F. Sun, P. Liu, H. Zhou, S. Fu, The current state of CuCrZr and CuCrNb alloys manufactured by additive manufacturing: a review, *Mater. Des.* 224 (2022), 111419.
- [146] B. Blakey-Milner, P. Gradl, G. Snedden, M. Brooks, J. Pitot, E. Lopez, M. Leary, F. Berto, A. du Plessis, Metal additive manufacturing in aerospace: a review, *Mater. Des.* 209 (2021), 110008.
- [147] P.R. Gradl, T.W. Teasley, C.S. Protz, M.B. Garcia, D. Ellis, C. Kantzos, Advancing GRCop-based bimetallic additive manufacturing to optimize component design and applications for liquid rocket engines, in: *AIAA Propulsion and Energy 2021 Forum*, American Institute of Aeronautics and Astronautics, 2021.
- [148] P. Gradl, C. Protz, K. Cooper, C. Garcia, D. Ellis, L. Evans, GRCop-42 Development and Hot-fire Testing Using Additive Manufacturing Powder Bed Fusion for Channel-Cooled Combustion Chambers, <https://ntrs.nasa.gov/api/citations/20190030461/downloads/20190030461.pdf> (accessed on 02 July 2023).
- [149] W.D. Callister, *An Introduction: Material Science and Engineering*, John Wiley and Sons Inc, 2007.
- [150] J. Davis, *ASM specialty handbook*, in: *Aluminum and Aluminum Alloys*, 1993, pp. 207–216.
- [151] G. Rödler, F.G. Fischer, J. Preußner, V. Friedmann, C. Fischer, A. Weisheit, J. H. Schleifenbaum, Additive manufacturing of high-strength eutectic aluminium-nickel alloys – processing and mechanical properties, *J. Mater. Process. Technol.* 298 (2021), 117315.
- [152] D. Zhang, S. Sun, D. Qiu, M.A. Gibson, M.S. Dargusch, M. Brandt, M. Qian, M. Easton, Metal alloys for fusion-based additive manufacturing, *Adv. Eng. Mater.* 20 (2018), 1700952.
- [153] J.C. Benedyk, *Additive Manufacturing and Aluminium Alloys*, 2018.
- [154] C. Kliemt, *Thermo-mechanical Fatigue of Cast Aluminium Alloys for Engine Applications under Severe Conditions*, Heriot-Watt University, 2012.
- [155] S.C. Altparmak, V.A. Yardley, Z. Shi, J. Lin, Challenges in additive manufacturing of high-strength aluminium alloys and current developments in hybrid additive manufacturing, *Int. J. Lightw. Mater. Manuf.* 4 (2021) 246–261.
- [156] A. Aversa, G. Marchese, A. Saboori, E. Bassini, D. Manfredi, S. Biamino, D. Ugues, P. Fino, M. Lombardi, New aluminum alloys specifically designed for laser powder bed fusion: a review, *Materials* 12 (2019), 1007.
- [157] 3T Additive Manufacturing Ltd., *Aluminium A20X™ Material Data Sheet*, [https://www.3t-am.com/sites/threeT/files/Aluminium%20A20X\\_Datasheet.pdf](https://www.3t-am.com/sites/threeT/files/Aluminium%20A20X_Datasheet.pdf) (accessed on 02 March 2022).
- [158] EOS GmbH, *EOS Aluminium AlSi10Mg Material Data Sheet*, [https://www.eos.info/03\\_system-related-assets/material-related-contents/metal-materials-and-examples/metal-material-datasheet/aluminium/material\\_datasheet\\_eos\\_aluminium-a\\_lsi10mg\\_en\\_web.pdf](https://www.eos.info/03_system-related-assets/material-related-contents/metal-materials-and-examples/metal-material-datasheet/aluminium/material_datasheet_eos_aluminium-a_lsi10mg_en_web.pdf) (accessed on 02 March 2022).
- [159] M. Awd, J. Tenkamp, M. Hirtler, S. Siddique, M. Bambach, F. Walther, Comparison of microstructure and mechanical properties of Scalloy® produced by selective laser melting and laser metal deposition, *Materials* 11 (2018), 17.
- [160] M.L. Montero-Sistiaga, R. Mertens, B. Vrancken, X. Wang, B. Van Hooreweder, J.-P. Kruth, J. Van Humbeeck, Changing the alloy composition of Al7075 for better processability by selective laser melting, *J. Mater. Process. Technol.* 238 (2016) 437–445.
- [161] M.A. Green, Self-consistent optical parameters of intrinsic silicon at 300K including temperature coefficients, *Sol. Energy Mater. Sol. Cells* 92 (2008) 1305–1310.
- [162] W.R. Osório, N. Cheung, J.E. Spinelli, P.R. Goulart, A. Garcia, The effects of a eutectic modifier on microstructure and surface corrosion behavior of Al-Si hypoeutectic alloys, *J. Solid State Electrochem.* 11 (2007) 1421–1427.
- [163] W.M. Haynes, *CRC Handbook of Chemistry and Physics*, CRC Press, 2016.
- [164] N.T. Aboulkhair, I. Maskery, C. Tuck, I. Ashcroft, N.M. Everitt, The microstructure and mechanical properties of selectively laser melted AlSi10Mg: the effect of a conventional T6-like heat treatment, *Mater. Sci. Eng. A* 667 (2016) 139–146.
- [165] A.L.H. Committee, *ASM Handbook*, ASM International, 1990.
- [166] L. Xi, D. Gu, S. Guo, R. Wang, K. Ding, K.G. Prashanth, Grain refinement in laser manufactured Al-based composites with TiB<sub>2</sub> ceramic, *J. Mater. Res. Technol.* 9 (2020) 2611–2622.
- [167] H.R. Kotadia, G. Gibbons, A. Das, P.D. Howes, A review of Laser Powder Bed Fusion Additive Manufacturing of aluminium alloys: microstructure and properties, *Addit. Manuf.* 46 (2021), 102155.
- [168] B.S. Murty, S.A. Kori, M. Chakraborty, Grain refinement of aluminium and its alloys by heterogeneous nucleation and alloying, *Int. Mater. Rev.* 47 (2002) 3–29.
- [169] P. Rometsch, Q. Jia, K.V. Yang, X. Wu, 14 - Aluminium alloys for selective laser melting – towards improved performance, in: F. Froes, R. Boyer (Eds.), *Additive Manufacturing for the Aerospace Industry*, Elsevier, 2019, pp. 301–325.
- [170] Z. Ahmad, The properties and application of scandium-reinforced aluminum, *JOM* 55 (2003) 35–39.
- [171] P. Ponnusamy, R.A. Rahman Rashid, S.H. Masood, D. Ruan, S. Palanisamy, Mechanical properties of SLM-printed aluminium alloys: a review, *Materials* 13 (2020), 4301.
- [172] N. Read, W. Wang, K. Essa, M.M. Attallah, Selective laser melting of AlSi10Mg alloy: Process optimisation and mechanical properties development, *Mater. Des.* (1980–2015), 65 (2015) 417–424.
- [173] MakeItFrom, <https://www.makeitfrom.com/material-properties/A201.0-A201.0-T7-A12010-Cast-Aluminum> (accessed on 07 March 2022).
- [174] Eckart, A20X™ – the strongest aluminium alloy, Worldwide, <https://eckart.net/de/en/microsite/am> (accessed on 07 March 2022).
- [175] MakeItFrom, EN AC-43000 (AlSi10Mg(a)) Cast Aluminum, [https://www.makeitfrom.com/material-properties/EN-AC-43000-AISI10Mg\(a\)-Cast-Aluminum](https://www.makeitfrom.com/material-properties/EN-AC-43000-AISI10Mg(a)-Cast-Aluminum) (accessed on 07 March 2022).
- [176] D. Koutny, D. Skulina, L. Panteljejev, D. Paloušek, B. Lenczowski, F. Palm, A. Nick, Processing of Al-Sc aluminum alloy using SLM technology, *Proc. CIRP* 74 (2018) 44–48.
- [177] P. Fathi, M. Mohammadi, X. Duan, A.M. Nasiri, Effects of surface finishing procedures on corrosion behavior of DMLS-AlSi10Mg\_200C alloy versus die-cast A360.1 aluminum, *JOM* 71 (2019) 1748–1759.
- [178] A. Leon, E. Aghion, Effect of surface roughness on corrosion fatigue performance of AlSi10Mg alloy produced by Selective Laser Melting (SLM), *Mater. Charact.* 131 (2017) 188–194.
- [179] T. Rubben, R.I. Revilla, I. De Graeve, Influence of heat treatments on the corrosion mechanism of additive manufactured AlSi10Mg, *Corros. Sci.* 147 (2019) 406–415.
- [180] A. Zakay, E. Aghion, Effect of post-heat treatment on the corrosion behavior of AlSi10Mg alloy produced by additive manufacturing, *JOM* 71 (2019) 1150–1157.
- [181] G. Sander, J. Tan, P. Balan, O. Gharbi, D. Feenstra, L. Singer, S. Thomas, R. Kelly, J.R. Scully, N. Birbilis, Corrosion of additively manufactured alloys: a review, *Corrosion* 74 (2018) 1318–1350.
- [182] L. Girelli, M. Tocci, L. Montesano, M. Gelfi, A. Pola, Investigation of cavitation erosion resistance of AlSi10Mg alloy for additive manufacturing, *Wear* 402–403 (2018) 124–136.
- [183] A. Leon, A. Shirizly, E. Aghion, Corrosion behavior of AlSi10Mg alloy produced by additive manufacturing (AM) vs its counterpart gravity cast alloy, *Metals* 6 (2016), 148.
- [184] P. Wang, A. Gebert, L. Yan, H. Li, C. Lao, Z. Chen, K. Kosiba, U. Kühn, S. Scudino, Corrosion of Al-3.5Cu-1.5 Mg–1Si alloy prepared by selective laser melting and heat treatment, *Intermetallics* 124 (2020), 106871.
- [185] Y. Guo, G.S. Frankel, Characterization of trivalent chromium process coating on AA2024-T3, *Surf. Coat. Technol.* 206 (2012) 3895–3902.
- [186] R. Saillard, S. Zanna, A. Seyeux, B. Fori, J. Swiatowska, C. Blanc, P. Marcus, Influence of ageing on the corrosion behaviour of 2024 aluminium alloy coated with a trivalent chromium conversion layer, *Corros. Sci.* 182 (2021), 109192.
- [187] A.C. Bouali, M. Serdechnova, C. Blawert, J. Tedim, M.G.S. Ferreira, M. L. Zheludkevich, Layered double hydroxides (LDHs) as functional materials for the corrosion protection of aluminum alloys: a review, *Appl. Mater. Today* 21 (2020), 100857.
- [188] R.M. Bandeira, J. van Druenen, A.C. Garcia, G. Tremiliosi-Filho, Influence of the thickness and roughness of polyaniline coatings on corrosion protection of AA7075 aluminum alloy, *Electrochim. Acta* 240 (2017) 215–224.
- [189] M. Zheludkevich, I.M. Salvado, M. Ferreira, Sol–gel coatings for corrosion protection of metals, *J. Mater. Chem.* 15 (2005) 5099–5111.
- [190] H. Takahashi, M. Sunada, T. Kikuchi, M. Sakairi, S. Hirai, Formation of Al-Si composite oxide films on aluminum by electrophoretic sol-gel coating/anodizing, in: P. Marcus, V. Maurice (Eds.), *Passivation of Metals and Semiconductors, and Properties of Thin Oxide Layers*, Elsevier Science, Amsterdam, 2006, pp. 685–690.
- [191] F. Simchen, M. Sieber, A. Kopp, T. Lampke, Introduction to plasma electrolytic oxidation—an overview of the process and applications, *Coatings* 10 (2020), 628.
- [192] Heat treating of aluminum and its alloys, in: G.E. Totten (ed.) *Heat Treating of Nonferrous Alloys*, Vol. 4E, ASM International, 2016.
- [193] A.B. Spierings, K. Dawson, K. Kern, F. Palm, K. Wegener, SLM-processed Sc- and Zr-modified Al-Mg alloy: mechanical properties and microstructural effects of heat treatment, *Mater. Sci. Eng. A* 701 (2017) 264–273.
- [194] C.N. Kuo, P.C. Peng, D.H. Liu, C.Y. Chao, Microstructure evolution and mechanical property response of 3D-printed scalloped alloy with different heat-treatment times at 325 °C, *Metals* 11 (2021), 555.

- [195] Carpenter Additive, Scalmalloy Data Sheet, [https://f.hubspotusercontent10.net/hubfs/6205315/Resources/Data%20Sheets/20210624-Scalmalloy\\_Datasheet\\_Digital\\_F.pdf](https://f.hubspotusercontent10.net/hubfs/6205315/Resources/Data%20Sheets/20210624-Scalmalloy_Datasheet_Digital_F.pdf) (accessed on 07 March 2022).
- [196] S. Baig, S.R. Ghiaasiaan, N. Shamsaei, Effect of heat treatment on the microstructure and mechanical properties of LB-PBF AlSi10Mg and scalmalloy, in: *Light Metals 2021*, Springer, 2021, pp. 119–125.
- [197] X. Yu, L. Wang, T6 heat-treated AlSi10Mg alloys additive-manufactured by selective laser melting, *Proc. Manuf.* 15 (2018) 1701–1707.
- [198] A. Sarentica, Conventional heat treatment of additively manufactured AlSi10Mg, 2019.
- [199] V. Mára, J. Krčil, L. Pilsová, Problematic of heat treatment and its influence on mechanical properties of selectively laser melted AlSi10Mg alloy, *Int. J. Adv. Manuf. Technol.* (2022).
- [200] B.J. Mfusi, N.R. Mathe, L.C. Tshabalala, P.A. Popoola, The effect of stress relief on the mechanical and fatigue properties of additively manufactured AlSi10Mg parts, *Metals* 9 (2019), 1216.
- [201] F. Beilelli, R. Casati, F. Larini, M. Riccio, M. Vedani, Investigation on two Ti-B-reinforced Al alloys for Laser Powder Bed Fusion, *Mater. Sci. Eng. A* 808 (2021), 140944.
- [202] L. Girelli, M. Tocci, M. Gelfi, A. Pola, Study of heat treatment parameters for additively manufactured AlSi10Mg in comparison with corresponding cast alloy, *Mater. Sci. Eng. A* 739 (2019) 317–328.
- [203] F. Beilelli, R. Casati, M. Riccio, A. Rizzi, M.Y. Kayacan, M. Vedani, Development of a novel high-temperature Al alloy for laser powder bed fusion, *Metals* 11 (2021), 35.